



DSX CableAnalyzer™

Users Manual



99 Washington Street
Melrose, MA 02176
Phone 781-665-1400
Toll Free 1-800-517-8431



Visit us at www.TestEquipmentDepot.com

May 2013 (English)

©2013 Fluke Corporation

All product names are trademarks of their respective companies.

LIMITED WARRANTY AND LIMITATION OF LIABILITY

Each Fluke Networks product is warranted to be free from defects in material and workmanship under normal use and service. The warranty period for the mainframe is one year and begins on the date of purchase. Parts, accessories, product repairs and services are warranted for 90 days, unless otherwise stated. Ni-Cad, Ni-MH and Li-Ion batteries, cables or other peripherals are all considered parts or accessories. The warranty extends only to the original buyer or end user customer of a Fluke Networks authorized reseller, and does not apply to any product which, in Fluke Networks' opinion, has been misused, abused, altered, neglected, contaminated, or damaged by accident or abnormal conditions of operation or handling. Fluke Networks warrants that software will operate substantially in accordance with its functional specifications for 90 days and that it has been properly recorded on non-defective media. Fluke Networks does not warrant that software will be error free or operate without interruption.

Fluke Networks authorized resellers shall extend this warranty on new and unused products to end-user customers only but have no authority to extend a greater or different warranty on behalf of Fluke Networks. Warranty support is available only if product is purchased through a Fluke Networks authorized sales outlet or Buyer has paid the applicable international price. Fluke Networks reserves the right to invoice Buyer for importation costs of repair/replacement parts when product purchased in one country is submitted for repair in another country.

Fluke Networks warranty obligation is limited, at Fluke Networks option, to refund of the purchase price, free of charge repair, or replacement of a defective product which is returned to a Fluke Networks authorized service center within the warranty period.

To obtain warranty service, contact your nearest Fluke Networks authorized service center to obtain return authorization information, then send the product to that service center, with a description of the difficulty, postage and insurance prepaid (FOB destination). Fluke Networks assumes no risk for damage in transit. Following warranty repair, the product will be returned to Buyer, transportation prepaid (FOB destination). If Fluke Networks determines that failure was caused by neglect, misuse, contamination, alteration, accident or abnormal condition of operation or handling, or normal wear and tear of mechanical components, Fluke Networks will provide an estimate of repair costs and obtain authorization before commencing the work. Following repair, the product will be returned to the Buyer transportation prepaid and the Buyer will be billed for the repair and return transportation charges (FOB Shipping point).

THIS WARRANTY IS BUYER'S SOLE AND EXCLUSIVE REMEDY AND IS IN LIEU OF ALL OTHER WARRANTIES, EXPRESS OR IMPLIED, INCLUDING BUT NOT LIMITED TO ANY IMPLIED WARRANTY OR MERCHANTABILITY OR FITNESS FOR A PARTICULAR PURPOSE. FLUKE NETWORKS SHALL NOT BE LIABLE FOR ANY SPECIAL, INDIRECT, INCIDENTAL OR CONSEQUENTIAL DAMAGES OR LOSSES, INCLUDING LOSS OF DATA, ARISING FROM ANY CAUSE OR THEORY.

Since some countries or states do not allow limitation of the term of an implied warranty, or exclusion or limitation of incidental or consequential damages, the limitations and exclusions of this warranty may not apply to every buyer. If any provision of this Warranty is held invalid or unenforceable by a court or other decision-maker of competent jurisdiction, such holding will not affect the validity or enforceability of any other provision.

4/04

Fluke Networks
PO Box 777
Everett, WA 98206-0777
USA

Contents

Chapter 1 Get Acquainted

Overview of Features	1
 Safety Information	2
Contact Fluke Networks	5
Register Your Product	5
Technical Reference Handbook	6
Additional Resources	6
Supplements and Updated Manuals	6
Kit Contents	7
Connectors, Keys, and LEDs	8
The Home Screen for the DSX CableAnalyzer	12
AC Adapter and Battery	15
Charge the Battery	15
Check the Battery Status	15
How to Use the Touchscreen	18
Verify Operation	20
Change the Language	20
Buttons to Do Tests and Save Results	20
Overview of Memory Functions	22
Options for Cable IDs	22
About Link Interface Adapters	24
How to Install a Strap	26
How to Remove or Install a Module	26
About LinkWare and LinkWare Stats Software	28
About the AxTalk Analyzer Kit	28

Chapter 2 How to Certify Twisted Pair Cabling

Make Sure Your Tester is Ready to Certify Cabling	29
Set the Reference	30
Settings for Twisted Pair Tests	31
How to Do an Autotest	36
“Bad Patch Cord” Message	38
Twisted Pair Autotest Results	39
PASS*/FAIL* Results	40
WIRE MAP Tab	40
PERFORMANCE Tab	42
Frequency-Domain Results	43
How to Save Frequency-Domain Results as a Plot or a Table	43
DIAGNOSTIC Tab	48

Chapter 3 Test Results

View Saved Results	49
How to Replace a Saved Result that Failed	52
Delete, Rename, and Move Results	52
Manage Results on a Flash Drive	54
Upload Results to a PC	55
View the Memory Status	57

Chapter 4 Projects

Why Use Projects?	59
Set Up a Project	60
The PROJECT Screen	60
The CABLE ID SETUP Screen	63
About Next ID Sets	63
Manage Projects on a Flash Drive	66

Copy Project Settings to Other Testers67

Chapter 5 Maintenance

Verify Operation70

Clean the Tester70

Traceable Calibration Period70

See Information About the Tester70

Update the Software71

Extend the Life of the Battery75

Store the Tester75

Remove the Battery75

Calibration76

If the Tester Does Not Operate as Usual76

Options and Accessories77

Certifications and Compliance78

Regulatory Information78

List of Figures

Figure		Page
1.	Main Tester Connectors, Keys, and LEDs.....	8
2.	Remote Tester Connectors, Keys, and LEDs	10
3.	The Home Screen for the DSX CableAnalyzer	12
4.	LEDs Show the Remote's Battery Status.....	16
5.	Connections to See the Status of the Remote's Battery.....	17
6.	How to Zoom the Screen.....	19
7.	FIX LATER, TEST AGAIN, and TEST Buttons and the TEST Key	21
8.	How to Attach and Remove Link Interface Adapters...	24
9.	How to Prevent Damage to the Permanent Link Adapter Cables.....	25
10.	How to Install a Strap and Use the Hand Strap	26
11.	How to Remove and Install a Module	27
12.	Reference Connections for Twisted Pair Cable	31
13.	Outlet Configurations	35
14.	Equipment for Autotests on Twisted Pair Cable.....	36
15.	Permanent Link Connections	37
16.	Channel Connections.....	38
17.	PASS* and FAIL* Results.....	40
18.	WIRE MAP Tab	41
19.	PERFORMANCE Tab	42
20.	Tabular Results Screen for a Frequency-Domain Test ..	44
21.	Plot Screen for a Frequency-Domain Test	46
22.	RESULTS Screen	50

23.	How to Connect the Tester to a PC	56
24.	PROJECT Screen	61
25.	CABLE ID SETUP Screen (after you enter the first and last IDs).....	64
26.	How to Connect the Tester to a PC	72
27.	How to Connect Units Together to Update the Software	74
28.	How to Remove the Battery	76

Chapter 1: Get Acquainted

Overview of Features

The Fluke Networks DSX CableAnalyzer™ modules attach to Versiv™ main and remote units to make rugged, hand-held testers that let you certify, troubleshoot, and document twisted pair network cabling. The testers includes these features:





- DSX-5000 modules certify twisted pair cabling to Class F_A limits (1000 MHz) in less than 15 seconds.
- Gives a PASS or FAIL result based on a test limit that you specify.
- You can save approximately 12,700 Cat 6A Autotest results, with plot data, in the tester's internal memory. You can save more results on a removable flash drive.
- AxTalk software supplied with DSX-5000 modules lets you do tests for alien crosstalk.
- Touchscreen lets you quickly navigate through different views of the results and see more information about cables.
- Lets you set up projects to specify the types of tests and the cable IDs necessary for a job and monitor the progress and status of the job.
- LinkWare™ software lets you upload test results to a PC and make professional-quality test reports.
- LinkWare Stats software makes browsable, graphical reports of cable test statistics.

Safety Information

Table 1 shows the international electrical symbols used on the tester or in this manual. Symbols for certifications and compliance are on page 78.

Ⓞ: This key turns the tester on and off.

Table 1. International Electrical Symbols

	Warning: Risk of fire, electric shock, or personal injury.
	Warning or Caution: Risk of damage or destruction to equipment or software. See explanations in the manuals.
	Do not connect this equipment to public communications networks, such as telephone systems.
	Do not put products containing circuit boards into the garbage. Dispose of circuit boards in accordance with local regulations.

Warning

To prevent possible fire, electric shock, or personal injury:

- Do not connect the tester to telephony inputs, systems, or equipment, including ISDN inputs. Doing so is a misapplication of this product, which could result in damage to the tester and create a potential shock hazard to the user.
- Use only AC adapters approved by Fluke Networks for use with the tester to supply power to the tester and charge the battery.
- Do not put the battery pack in a fire or an environment with temperatures more than 140 °F (60 °C).
- Do not use the tester in damp or wet environments.
- Do not short-circuit or disassemble the battery pack.

- Do not use the tester if it is damaged. Inspect the tester before use.
- Do not open the case; no user-serviceable parts are inside.
- Do not modify the tester.
- If this equipment is used in a manner not specified by the manufacturer, the protection provided by the equipment can possibly be impaired.

 **Caution**

To prevent damage to the tester or cables under test, to prevent data loss, and to make sure your test results are as accurate as possible:

- Do not connect the tester to an active network. Doing so causes unreliable test results, can disrupt network operations, and can cause damage to the tester.
- Connect to the adapters only plugs that are made for Ethernet applications, such as RJ45, ARJ45, and Cat 7 plugs. Other types of plugs, such as RJ11 (telephone) plugs, can cause permanent damage to the jacks.
- To make sure your test results are as accurate as possible, do the reference procedure every 30 days. See “About Link Interface Adapters” on page 24.
- Connect the AC adapter or replace the battery as soon as the low battery indication appears.
- Keep modules attached to the main and remote Versiv units to give protection to the module connectors.
- Do not remove the USB flash drive while the LED on the drive flashes. Doing so can corrupt the data on the drive.
- You can lose a USB flash drive, cause damage to it, or accidentally erase the contents of the drive. Thus,

Fluke Networks recommends that you save no more than one day of test results on a flash drive.

- **Do not operate portable transmitting devices, such as walkie-talkies and cell phones, during a cable test. Doing so can cause errors in test results.**
- **Do not twist, pull on, pinch, crush, or make kinks in the cables on the permanent link adapters. See Figure 9 on page 25.**



99 Washington Street
Melrose, MA 02176
Phone 781-665-1400
Toll Free 1-800-517-8431



Register Your Product

Registering your product with Fluke Networks gives you access to valuable information on product updates, trouble

Technical Reference Handbook

The *Versiv Technical Reference Handbook* has more information about the tester. The Handbook is on the Versiv Product Manuals CD included with your product, and on the Fluke Networks website.

Additional Resources

The Fluke Networks Knowledge Base answers common questions about Fluke Networks products and provides articles on cable testing techniques and technology.

Kit Contents

The DSX kit comes with the accessories in the lists below. If something is damaged or missing, contact the place of purchase immediately.

- Versiv main unit with battery pack
- Versiv remote with battery pack
- Two DSX-5000 modules for tests to 1000 MHz
- Two DSX-PLA004 Cat 6A/Class E_A permanent link adapters
- Two DSX-CHA004 Cat 6A/Class E_A channel adapters
- Carrying case for the testers
- Two carrying/hanging straps for the testers
- Two hand straps for the testers
- USB cable for PC communications, type A USB to Micro-B USB
- 2 headsets
- Two AC adapter/chargers
- DSX Getting Started Guide
- Versiv Product Manuals CD
- LinkWare Software CD
- AxTalk Analyzer kit (see "About the AxTalk Analyzer Kit" on page 28):
 - AxTalk Software CD
 - Two DTX-AXTERM alien crosstalk link terminators
 - 2 RJ45 universal adapters



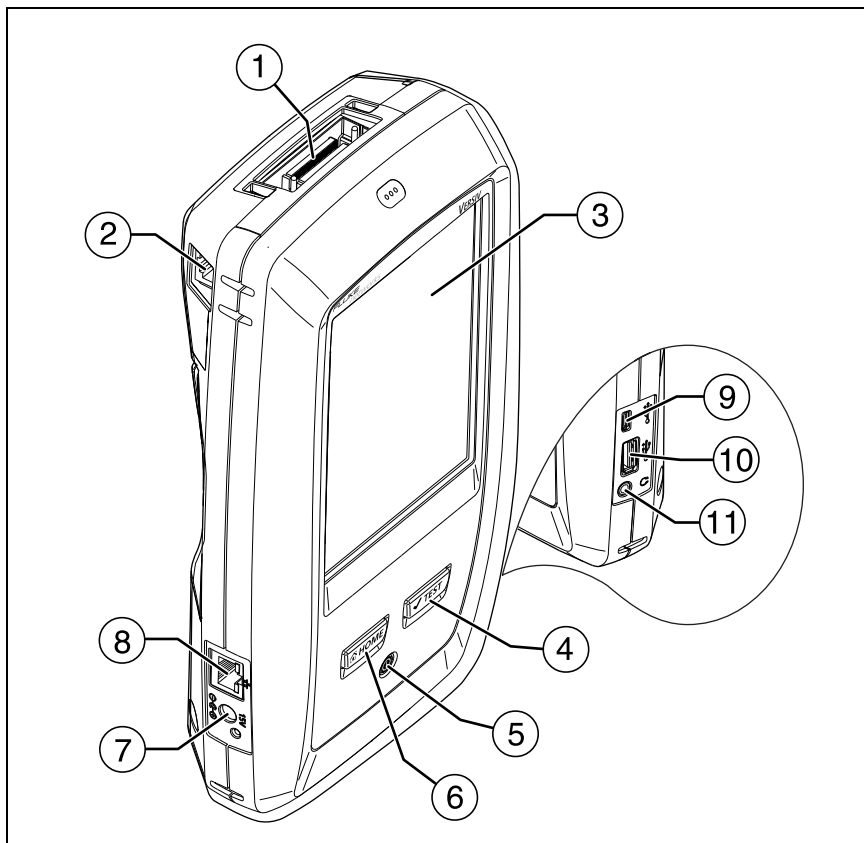

Connectors, Keys, and LEDs



GPU88.EPS

Figure 1. Main Tester Connectors, Keys, and LEDs

- ① Connector for a link interface adapter
- ② RJ45 jack for communications between the main and remote testers when you do alien crosstalk measurements. See “About the AxTalk Analyzer Kit” on page 28.
- ③ LCD display with touchscreen

- ④ : Starts a test. To start a test, you can also tap **TEST** on the display.
- ⑤ : Power key
- ⑥ : Press  to go to the home screen.
- ⑦ Connector for the AC adapter. The LED is red when the battery charges, and green when the battery is fully charged. The LED is yellow if the battery will not charge. See “Charge the Battery” on page 15.
- ⑧ RJ45 connector: For functions available in future software releases.
- ⑨ Micro-AB USB port: This USB port lets you connect the tester to a PC so you can upload test results to the PC and install software updates in the tester.
- ⑩ Type A USB port: This USB host port lets you save test results on a USB flash drive.
- ⑪ Headset jack

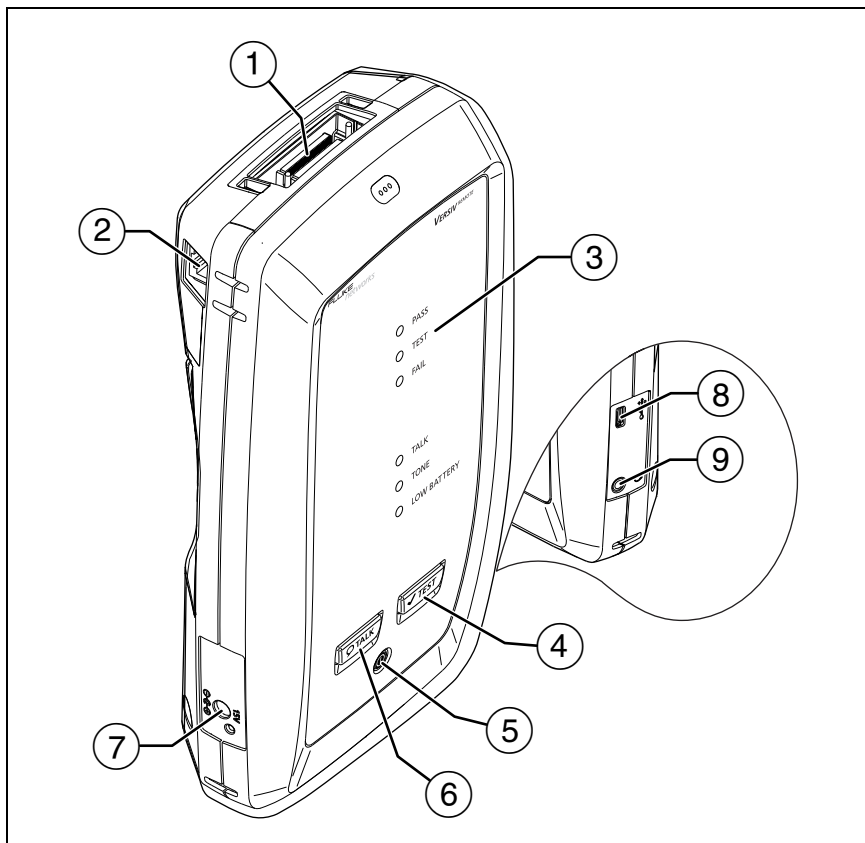

GPU42.EPS





Figure 2. Remote Tester Connectors, Keys, and LEDs

- ① Connector for a link interface adapter
- ② RJ45 jack for communications between the main and remote testers when you do alien crosstalk measurements. See “About the AxTalk Analyzer Kit” on page 28.
- ③ **PASS** LED comes on when a test passes.
TEST LED comes on during a test.
FAIL LED comes on when a test fails.

TALK LED comes on when the talk function is on.

LOW BATTERY LED comes on when the battery is low.

The LEDs also have these functions:

- Battery gauge (see Figure 4 on page 16)
 - Volume indicator for the **TALK** function
 - Progress indicator for software updates
- ④  **TEST**: Starts a test.
 - ⑤ : Power key
 - ⑥ : Press  to use the headset to speak to the person at the other end of the link. Press again to adjust the volume. To turn off the talk function, hold down .
 - ⑦ Connector for the AC adapter. The LED is red when the battery charges, and green when the battery is fully charged. The LED is yellow if the battery will not charge. See “Charge the Battery” on page 15.
 - ⑧ Micro-AB USB port: This USB port lets you connect the tester to a PC so you can install software updates in the tester.
 - ⑨ Headset jack

The Home Screen for the DSX CableAnalyzer



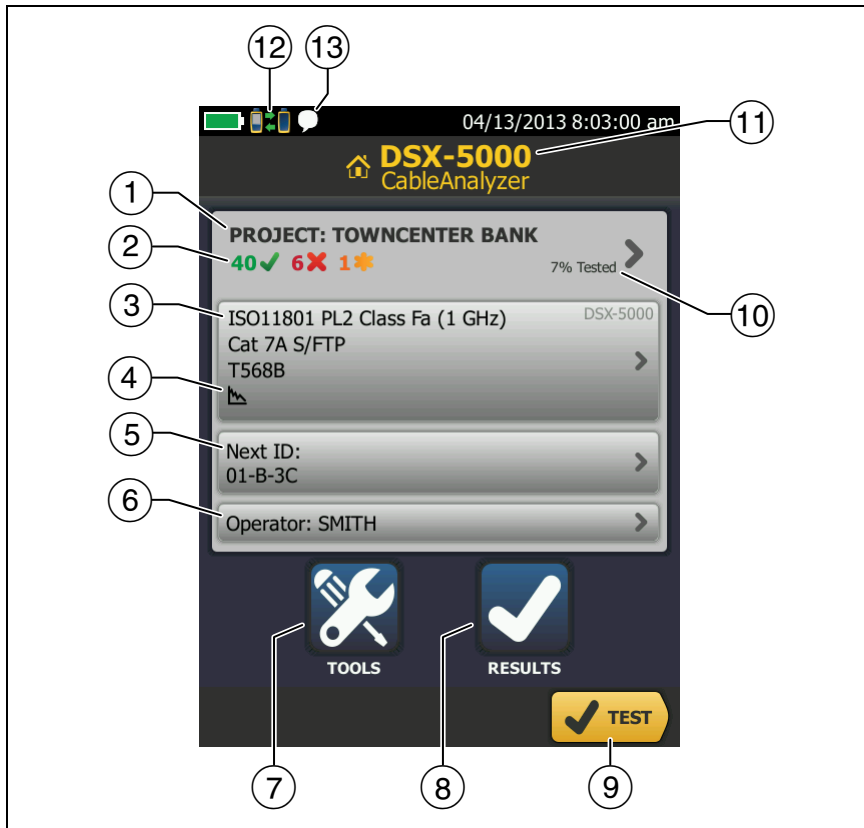

The home screen (Figure 3) shows important test settings. Before you do a test, make sure these settings are correct.



GPU110.EPS

Figure 3. The Home Screen for the DSX CableAnalyzer

- ① **PROJECT:** The project contains the settings for a job and helps you monitor the status of a job. When you save test results, the tester puts them in the project. Tap the **PROJECT** panel to edit the project settings, select a different project, or make a new project.

- ② Shows a summary of the test results in the project:
-  : The number of tests that passed.
 -  : The number of tests that failed.
 -  : The number of tests with an overall marginal result.
- ③ The test setup panel shows the settings the tester will use when you tap **TEST** or press . To change these settings, tap the panel.



Note

You can set up tests for any module that the tester can use, even when no module is attached.

- ④ Icons show the status of the **Store Plot Data** and **AC Wire Map** settings. See Table 2 on page 33.
- ⑤ **Next ID:** The **Next ID** panel shows the ID that the tester gives to the next test results you save.
- Tap **Next ID** to do these tasks:
- Enter an ID, select a different ID in the ID set, select a different set of IDs, or make a new set. The tester adds the IDs and ID sets you make to the project that shows on the home screen.
 - Turn **Auto Save** on or off.
- ⑥ **Operator:** The name of the person who does the job. You can enter a maximum of 20 operator names.
- ⑦ **TOOLS:** The **TOOLS** menu lets you set the reference, see the status of the tester, and set user preferences such as the language and the display brightness.
- ⑧ **RESULTS:** Tap **RESULTS** to see and manage the results that are saved in the tester.
- ⑨ **TEST:** Tap **TEST** to do the test shown in the test setup panel.

- ⑩ The percentage of the project that is completed. The percentage is the number of IDs used for saved results divided by the total number of used and available IDs in the project. The number of IDs includes IDs for copper and fiber cable.

% **Tested** does not show if your project contains only a **Next ID** list. See "About Next ID Sets" on page 63 for more information about the **Next ID** list.

- ⑪ The type of module attached to the main Versiv unit.
- ⑫  This icon shows when the tester's link interface adapter is connected to the adapter on a Versiv remote and the remote is turned on.
- ⑬  This icon shows when the talk function is on. To use the talk function:

- 1 Connect the main and remote testers together through a link that has one or more good wire pairs.
- 2 Connect headsets to the headset jacks on the testers
- 3 Press the button on one of the headset microphones or press  on the remote, then speak into the microphone.

AC Adapter and Battery

You can use the AC adapter (model VERSIV-ACUN) or the lithium ion battery (model VERSIV-BATTERY) to supply power to the tester.

To remove the battery, see “Remove the Battery” on page 75.

Charge the Battery

Before you use the battery for the first time, charge the battery for about 2 hours with the tester turned off.

To charge the battery

Connect the AC adapter to the tester. See item ⑦ in Figure 1. The LED near the AC adapter connector is red when the battery charges, and green when the battery is fully charged.

A fully-charged battery operates for approximately 8 hours of typical use. The battery takes approximately 4 hours to fully charge when the tester is turned off.

Notes

You do not need to fully discharge the battery before you recharge it.

The battery will not charge if its temperature is outside the range of 32 °F to 104 °F (0 °C to 40 °C). The LED near the connection for the AC adapter is yellow if the battery will not charge.

Check the Battery Status

On a main tester

The battery status icon is in the upper-left corner of the screen:



Battery is full.



Battery is approximately half full.

 If the AC adapter is not connected, the red bar shows that the battery is very low. Connect the AC adapter to charge the battery and make sure the tester continues to operate.

The red bar also shows if the AC adapter is connected, but the battery is not installed.

On a remote

The LEDs show the battery status at the end of the power-up sequence, as shown in Figure 4.

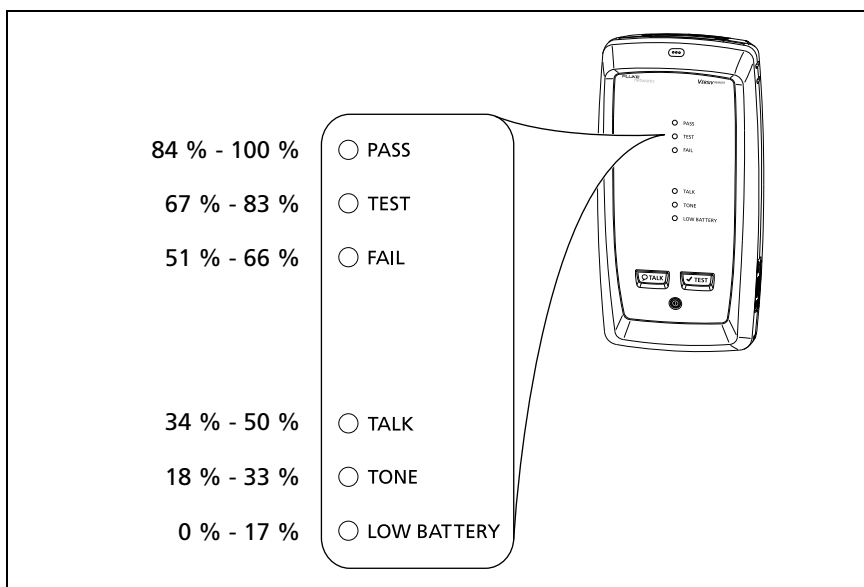

GPU102.EPS

Figure 4. LEDs Show the Remote's Battery Status

To see more information about the battery status

- 1 Make the connections shown in Figure 5 and turn on both testers.
- 2 Tap **TOOLS**, then tap **Battery Status**.

When the AC adapter is not connected, the screen shows the **Time Remaining**, which is the approximate battery life at the present rate of use.

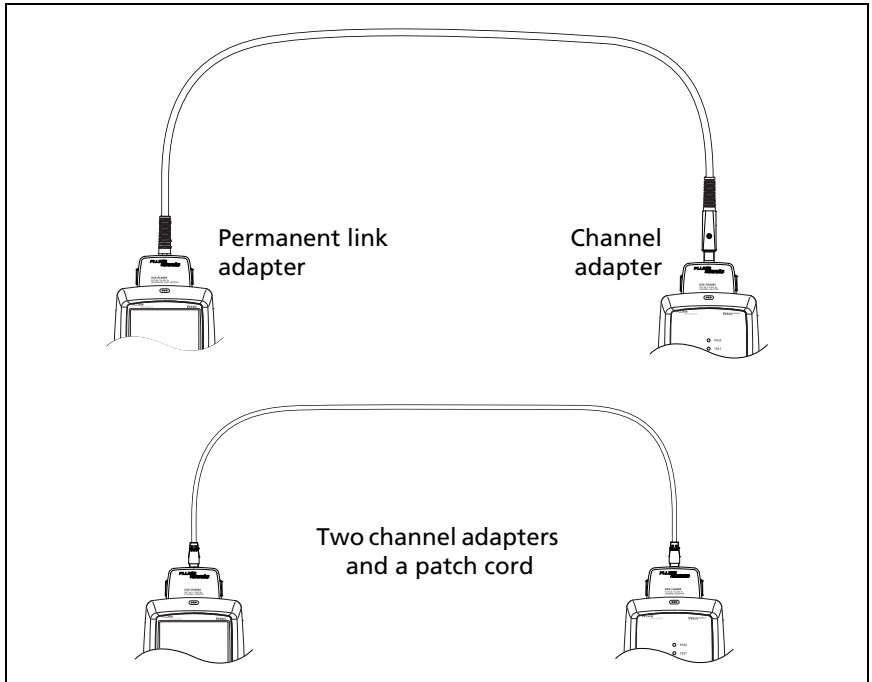

GPU89.EPS

Figure 5. Connections to See the Status of the Remote's Battery

How to Use the Touchscreen

The touchscreen lets you use fingertip gestures to control the tester. You can also operate the touchscreen with a stylus that is made for projected capacitance touchscreens.

Caution

For correct operation and to prevent damage to the touchscreen:

- **Touch the screen only with your fingers or with a stylus that is made for projected capacitance touchscreens. Do not use too much force.**
- **Do not touch the screen with sharp objects.**

Note

The touchscreen will not respond if you tap it with your fingernail or an incorrect type of stylus or if you wear non-conductive gloves.

To use the touchscreen

- To select an item on the screen, tap the item lightly with your fingertip.
- To scroll a screen, lightly touch the screen then move your fingertip in the direction you want the screen to move.
- On screens that show a plot, use the pinch and reverse-pinch gestures to change the magnification on the screen. See Figure 6.
- On screens that show a plot, you can drag some items, such as the measurement cursor on the trace.

To clean the touchscreen, turn off the tester, then use a soft, lint-free cloth that is moist with a mild detergent.

Caution

When you clean the touchscreen, do not let liquid get under the plastic around the touchscreen.

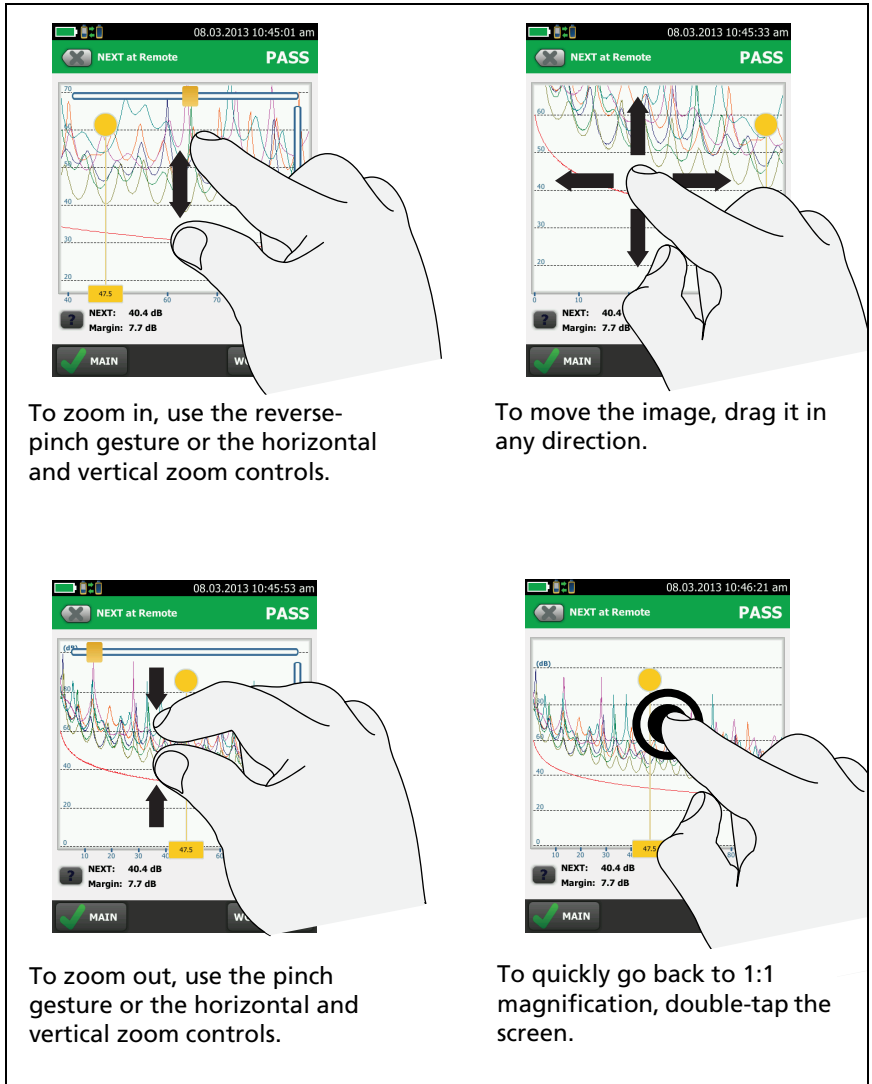

To zoom in, use the reverse-pinch gesture or the horizontal and vertical zoom controls.

To move the image, drag it in any direction.

To zoom out, use the pinch gesture or the horizontal and vertical zoom controls.

To quickly go back to 1:1 magnification, double-tap the screen.

Figure 6. How to Zoom the Screen

HEJ45.EPS

Verify Operation

The tester does a self test when you turn it on. If the tester shows an error or does not turn on, refer to “If the Tester Does Not Operate as Usual” on page 103.

Change the Language

On the home screen, tap the **TOOLS** icon, tap **Language**, then tap a language.

Buttons to Do Tests and Save Results

When a test is completed and more than one button shows at the bottom of the screen, the tester highlights one in yellow to recommend which one to tap. Figure 7 shows the buttons you will see.

Note

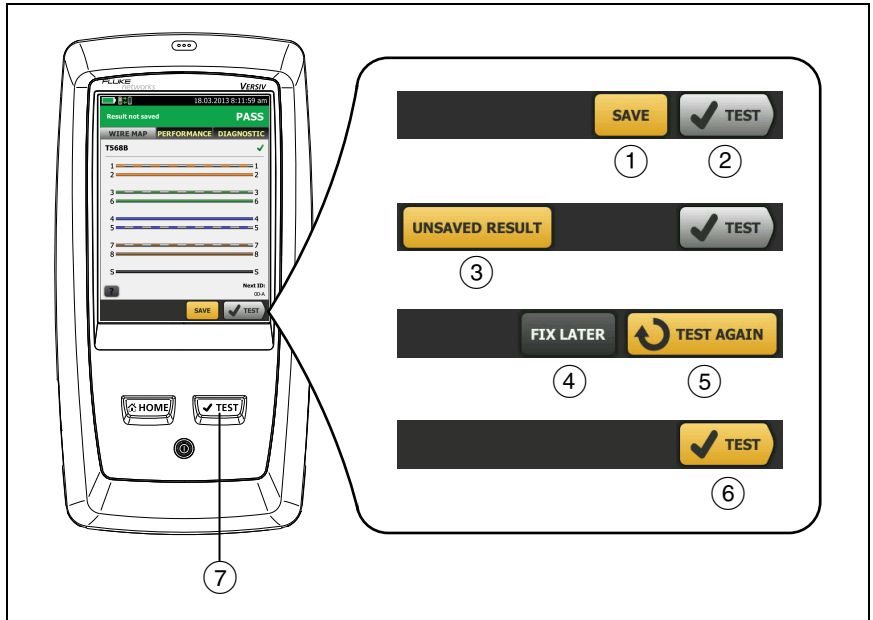

*To change the **Auto Save** setting, tap the **Next ID** panel on the home screen.*



GPU40.EPS

Figure 7. FIX LATER, TEST AGAIN, and TEST Buttons and the TEST Key

- ① **SAVE** (yellow), ② **TEST** (gray): These buttons show if the test passed and **Auto Save** is off. When you tap **SAVE**, you can save the results with an ID that you make or select. When you tap **TEST**, you can select to save the results or do the test again and not save the results.
- ③ **UNSAVED RESULT**: This button shows if **Auto Save** is off and you go to the home screen when a test is completed. Tap this button to see the result.
- ④ **FIX LATER**: This button shows if the test failed and **Auto Save** is off. Tap **FIX LATER** to save the results with an ID that you make or select.

- ⑤ **TEST AGAIN:** This button shows if the test failed. Tap this button to do the test again for the same ID. If **Auto Save** is on, the tester saves subsequent results with the same ID. If **Auto Save** is off, you can save the result if necessary. When you look at a result that failed, tap **TEST AGAIN** to do the test again for the same ID and with the same test settings as the saved result.
- ⑥ **TEST (yellow):** This button shows if the test passed and **Auto Save** is on. When **Auto Save** is on, the tester saves results with the next available ID when the test is completed. When you tap **TEST**, the tester does a test for the next available ID.
- ⑦ : Press  to do the test shown on the home screen for the **Next ID**.

Overview of Memory Functions

You can save approximately 12,700 Cat 6A Autotest results, with plot data included.

The capacity available for test results depends on the space used by the software and custom test limits in the tester.

To see the memory status

On the home screen, tap the **TOOLS** icon, then tap **Memory Status**.

To make more memory available, you can export results to a USB flash drive, then delete the results in the tester. See “Manage Results on a Flash Drive” on page 54.

Options for Cable IDs

When you save the test results for a cable, you usually give the results the name that is the ID for the cable. There are several methods you can use to make IDs for test results:

- You can use the **CABLE ID SETUP** screen to make a set of sequential IDs. The tester uses the IDs in sequence as the names for the results you save. When **Auto Save** is on, the tester automatically saves each result with the next available ID in the set. See Chapter 8.

A cable ID set also lets you use IDs again so you can add different results to tests you saved before.

- You can enter an ID each time you do a test. To do this, turn off the **Auto Save** function (see page 23). Each time a test is completed, tap **SAVE** (if the test passed) or **FIX LATER** (if the test failed), then enter an ID manually.
- You can use LinkWare software to make a set of IDs, download the set to the tester, then import it into a project.
- After you do a test, you can enter the ID for a test you saved before. This lets you replace results or add different results to a test you saved before.
- If the test failed before, and you saved the results, you can select it on the **RESULTS** screen, then press **TEST AGAIN** to replace the results for that ID.

Notes

Cable IDs are case-sensitive. For example, the tester saves result with the names "A0" and "a0" in two different records.

A cable ID can have a maximum of 60 characters.

If you delete all the ID sets in a project, the tester makes a default set that starts with 001.

To turn the Auto Save function on or off

- 1 On the home screen, tap the **Next ID** panel.
- 2 On the **CHANGE ID** screen, tap the **On/Off** control next to **Auto Save**.
- 3 Tap **DONE**.

About Link Interface Adapters

Link interface adapters let you connect the DSX CableAnalyzer to different types of twisted pair links. Figure 8 shows how to attach and remove adapters.

Caution

To prevent damage to the cables on the permanent link adapters and to make sure your test results are as accurate as possible, do not twist, pull on, pinch, crush, or make kinks in the cables. See Figure 9 on page 25.

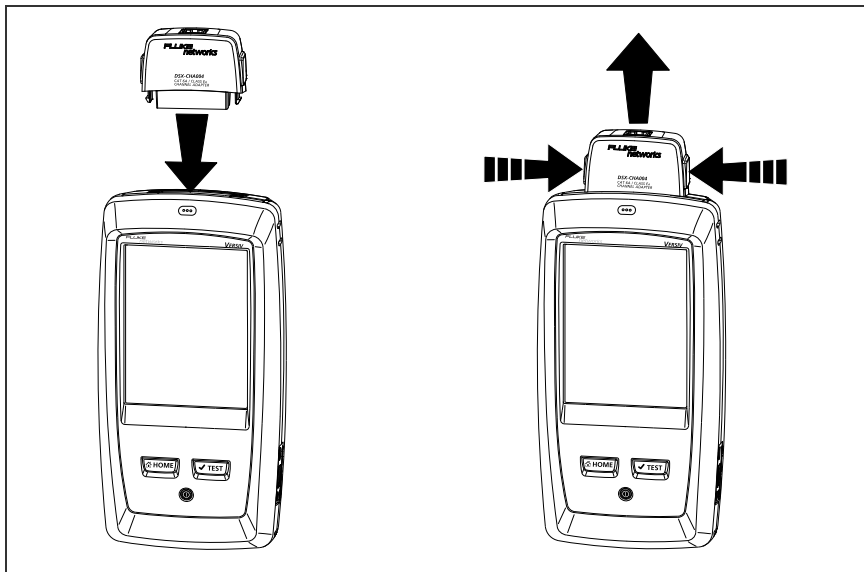

GPU109.EPS

Figure 8. How to Attach and Remove Link Interface Adapters

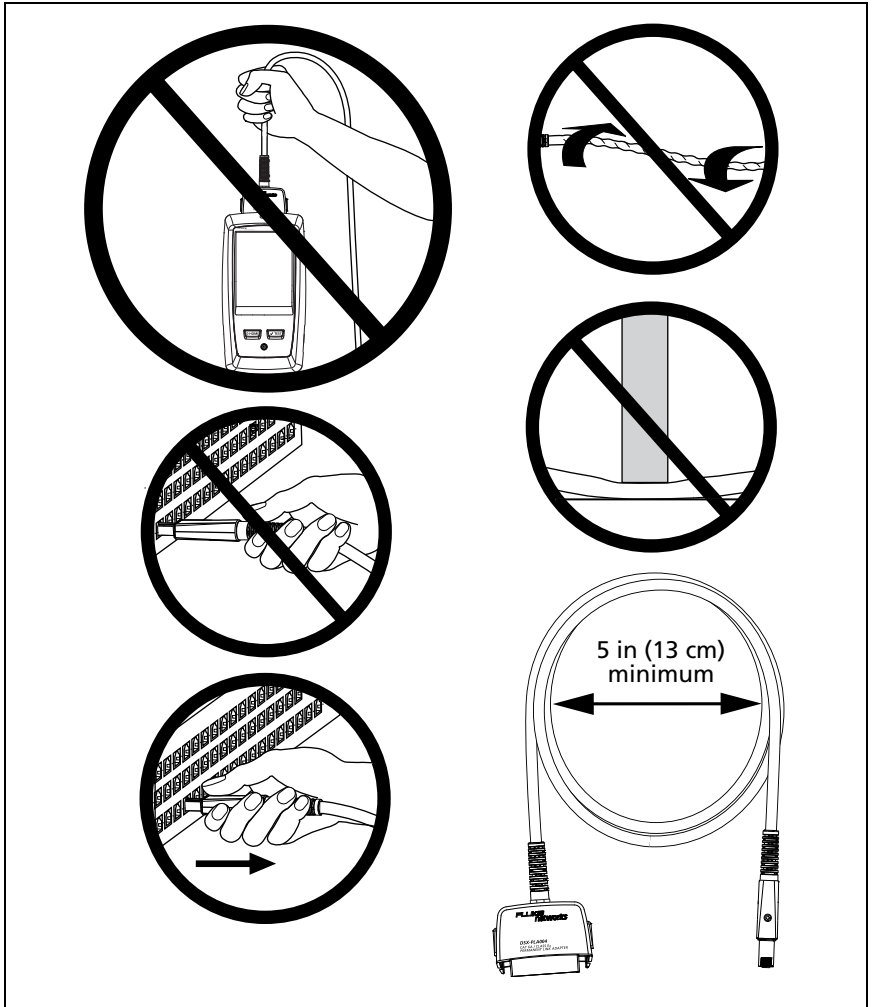

GPU108.EPS

Figure 9. How to Prevent Damage to the Permanent Link Adapter Cables

How to Install a Strap

Two types of straps are available for the tester: a hand strap that helps you hold the tester, and a carrying strap that lets you carry and hang the tester. Figure 10 shows how to install a strap and how to use the hand strap.

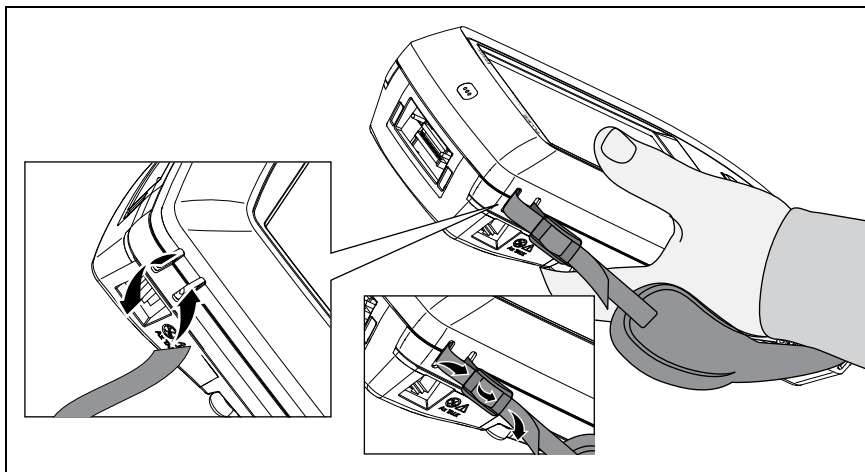

GPU43.EPS

Figure 10. How to Install a Strap and Use the Hand Strap

How to Remove or Install a Module

Figure 11 shows how to remove and install the module.

Note

It is not necessary to turn off the tester before you remove or install a module.

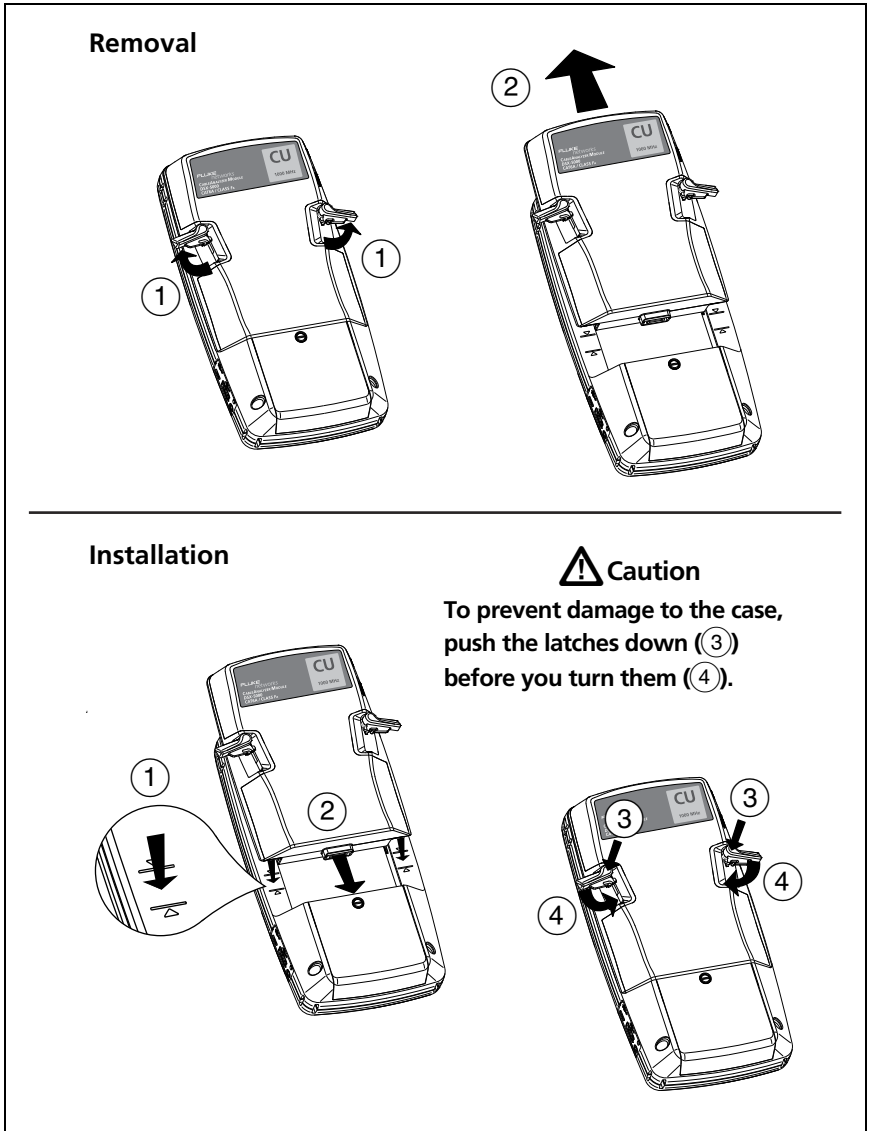

Figure 11. How to Remove and Install a Module

About LinkWare and LinkWare Stats Software

The LinkWare Cable Test Management software included with your tester lets you upload test records to a PC, organize and examine test results, print professional-quality test reports, and do software updates and other maintenance procedures on your tester.

Updates to LinkWare software are available on the Fluke Networks website.

The LinkWare Stats Statistical Report software that is included with LinkWare software provides statistical analysis of cable test reports and generates browsable, graphical reports.

For instructions about LinkWare and LinkWare Stats software, see the guides for getting started and the online help available under **Help** on the LinkWare and LinkWare Stats menus.

About the AxTalk Analyzer Kit

The DSX-5000 kit includes the hardware and AxTalk Analyzer software you need to do tests for alien crosstalk on twisted pair cabling. Alien crosstalk is noise, or crosstalk, transmitted between adjacent cables in a bundle or patch panel. Alien crosstalk is a primary source of noise in cabling used for 10GBASE-T applications.

For instructions on how to do alien crosstalk tests, install the AxTalk Analyzer software supplied on the AxTalk Analyzer software CD, then see the online help in the software.

Chapter 2: How to Certify Twisted Pair Cabling



Before you use the DSX CableAnalyzer, read the safety information that starts on page 2.

Make Sure Your Tester is Ready to Certify Cabling

To make sure your tester meets its accuracy specifications, follow these guidelines:

- Keep the tester's software current. The latest software is available on the Fluke Networks website. See "Update the Software" on page 71.
- Set the reference for the twisted pair adapters every 30 days. See page 30.
- Make sure that you select the correct cable type for the job, and that the NVP for the cable is correct. See Table 2 on page 32.
- Make sure you select the correct test limit for the job. See Table 2 on page 32.
- Make sure the cords and connectors for all test equipment and patch cords are in good condition.
- Make sure the battery is fully charged.
- Send the modules to a Fluke Networks service center every 12 months for factory calibration.

Set the Reference

The reference procedure for twisted pair cable sets the baseline for insertion loss, ACR-F, and DC resistance measurements.

Set the reference at these times:

- When you want to use the tester with a different remote. You can set the reference for eight different remotes.
- When you attach Class F/F_A link interface adapters, such as the optional DSX-PLA011 TERA™ adapters.
- Every 30 days. This ensures maximum accuracy of test results.

It is not necessary to set the reference when you change the link interface adapters.

To set the reference

- 1 Turn on the tester and the remote a minimum of 1 minute before you set the reference.

Note

Set the reference only after the testers are at an ambient temperature between 50 °F and 104 °F (10 °C and 40 °C).

- 2 Connect the main and remote testers together as shown in Figure 12.
- 3 If you attached Class F/F_A link interface adapters, make sure you select a Class F or F_A test limit. See the documentation supplied with the adapters.
- 4 On the home screen, tap **TOOLS**, then tap **Set Reference**.
- 5 On the **SET REFERENCE** screen tap **TEST**.

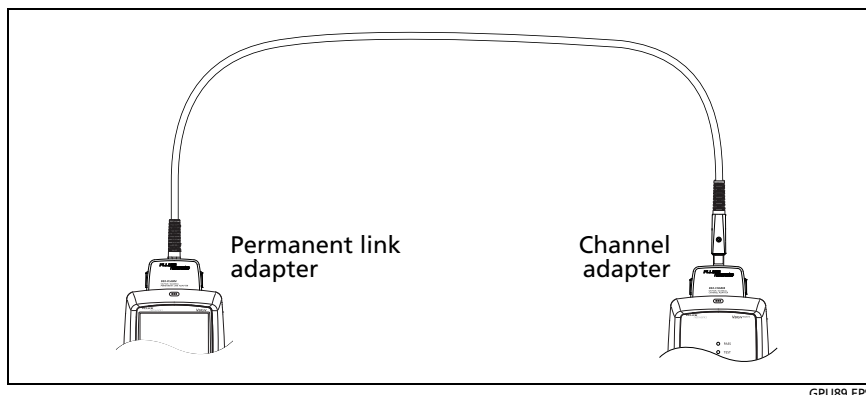

Figure 12. Reference Connections for Twisted Pair Cable

Settings for Twisted Pair Tests

Table 2 gives descriptions of the settings for twisted pair tests. To set up a project, which includes the settings in Table 2, cable IDs, and operator names, see Chapter 4.

To set up a twisted pair test

- 1 On the home screen, tap the test setup panel.
- 2 On the **CHANGE TEST** screen, select a twisted pair test to change, then tap **EDIT**.

Or to set up a new twisted pair test, tap **NEW TEST**. If no module is installed, the **MODULE** screen shows. Tap the correct copper module.

- 3 On the **TEST SETUP** screen, tap the panels to change settings for the test. See Table 2.
- 4 On the **TEST SETUP** screen, tap **SAVE** when your test setup is completed.
- 5 On the **CHANGE TEST** screen, make sure the button next to the test is selected, then tap **USE SELECTED**.

Table 2. Settings for Twisted Pair Tests





Setting	Description
Module	Select DSX-5000 CableAnalyzer .
Cable Type	Select a cable type that is correct for the type you will test. To see a different group of cable types, tap MORE , then tap a group. To make a custom cable type, tap Custom in the Cable Groups list.
NVP	<p>Nominal velocity of propagation. The tester uses the NVP and the propagation delay to calculate the length of the cable.</p> <p>The default value is defined by the selected cable type and is the typical NVP for that cable type. To enter a different value, tap the NVP panel, then tap  or  on the NVP screen to increase or decrease the value.</p> <p>To find the actual value for a cable, connect a known length of the cable to the tester, tap MEASURE on the NVP screen, then change the NVP until the measured length matches the known length. Use a cable at least 30 m (100 ft) long.</p> <p>When you increase the NVP value, the calculated length increases.</p>
Shield Test	This setting shows only when you select a shielded cable type. When you set Shield Test to On , the wire map test includes a test for shield continuity.
Test Limit	Select the correct test limit for the job. To see a different group of limits, tap MORE , then tap the name of a group.

Table 2. Settings for Twisted Pair Tests (continued)

Store Plot Data	<p>Off : The tester does not save plot data for frequency-domain tests or for the HDTDR/HDTDX analyzers. You can see the plots before you save the test and exit the results screen. The saved results show frequency-domain measurements in a table and do not include the HDTDR/HDTDX plots.</p> <p>On : The tester saves plot data for all frequency-domain tests required by the selected test limit and for the HDTDR/HDTDX analyzers.</p>
HDTDR/HDTDX	<p>Fail/Pass* only: The tester shows HDTDR and HDTDX analyzer results only for Autotests with PASS*, FAIL*, or FAIL results.</p> <p>All Autotests: The tester shows HDTDR and HDTDX analyzer results for all Autotests.</p> <p>To get HDTDR/HDTDX analyzer results you can also tap Tools > Diagnostics.</p> <p>For more information about the HDTDR and HDTDX analyzers, see the Technical Reference Handbook.</p>
Outlet Configuration	<p>The Outlet Configuration specifies which wire pairs are tested and which wire numbers the wire map shows for the pairs. See Figure 13.</p> <p>To see the wire map for a configuration, tap Outlet Configuration, tap the configuration name on the OUTLET CONFIG screen, then tap SAMPLE.</p> <p>To select a configuration, tap a name on the OUTLET CONFIG screen, then tap USE SELECTED.</p> <p style="text-align: center;"><i>Note</i></p> <p style="text-align: center;"><i>The OUTLET CONFIG screen shows only the configurations that are applicable to the selected Test Limit.</i></p>

-continued-

Table 2. Settings for Twisted Pair Tests (continued)

AC Wire Map	<p>The AC Wire Map test lets you do tests on links connected through midspan PoE (Power over Ethernet) devices. See the Technical Reference Handbook.</p> <p>When the AC Wire Map test is on, this icon shows on the home screen: </p> <p style="text-align: center;"><i>Note</i></p> <p><i>Always turn off the AC wire map test when you will not do tests through a PoE device. The AC wire map test increases the time for an Autotest.</i></p>
--------------------	---

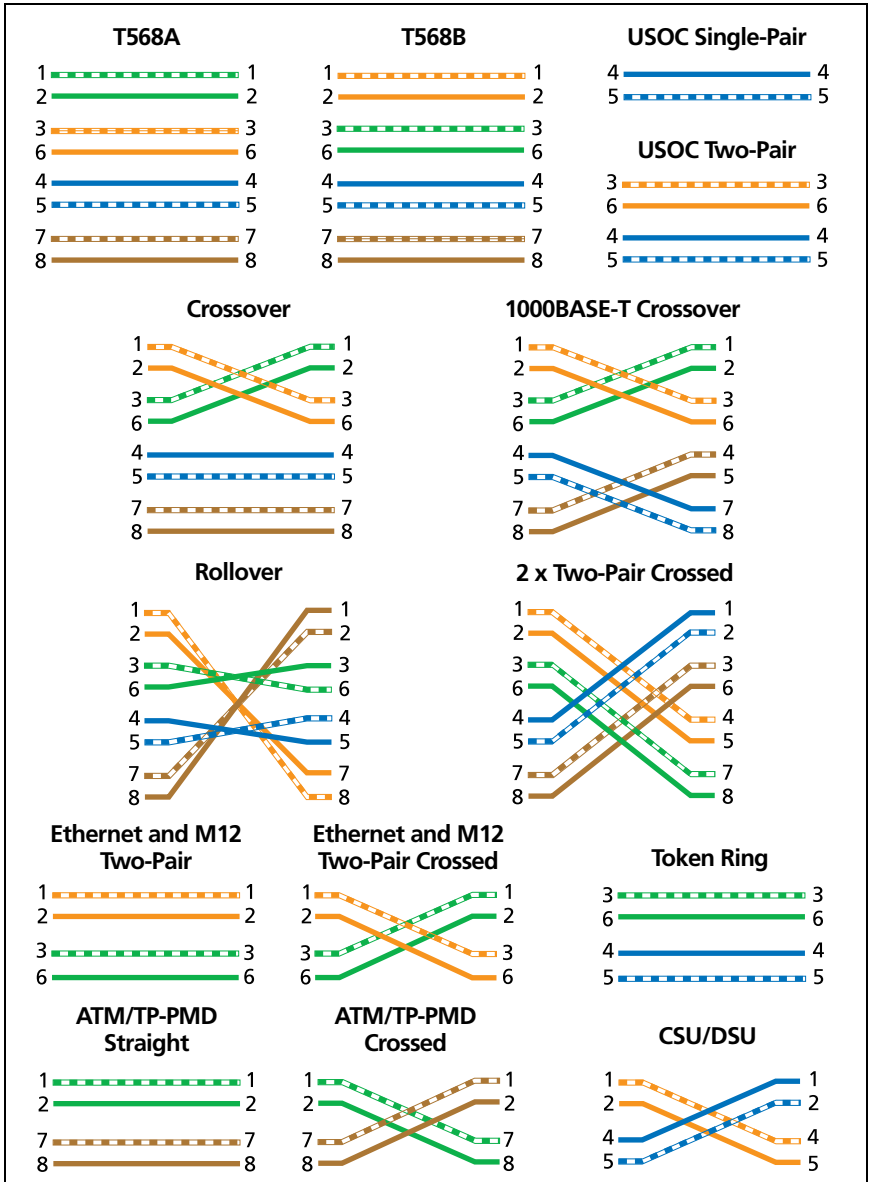

GPU85.EPS

Figure 13. Outlet Configurations

How to Do an Autotest

When you tap **TEST** on the main tester or press  on the main or remote tester, the testers do an Autotest. The Autotest includes all the tests necessary to certify that the cabling meets or exceeds the performance requirements specified in the selected test limit.

Figure 14 shows the equipment for Autotests on twisted pair cable.

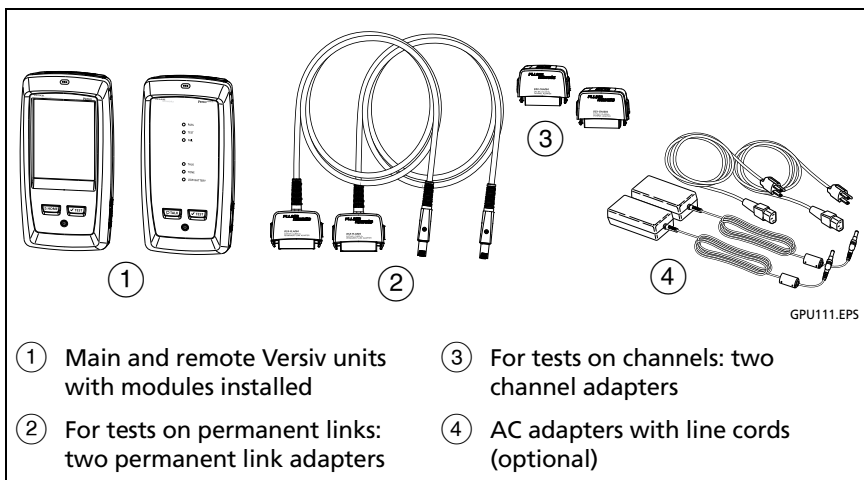

Figure 14. Equipment for Autotests on Twisted Pair Cable

To do an Autotest on twisted pair cable

- 1 Attach permanent link or channel adapters to the main and remote testers.
- 2 Make sure that the home screen shows the correct settings for the job.

To make sure that other settings are correct, tap the test setup panel, make sure the correct test is selected on the **CHANGE TEST SCREEN**, then tap **EDIT** to see more settings. Table 2 on page 32 describes the settings.

- 3 Connect the testers to the link as shown in Figure 15 or 16.
- 4 Tap **TEST** on the main tester or press **TEST** on the main or remote tester.

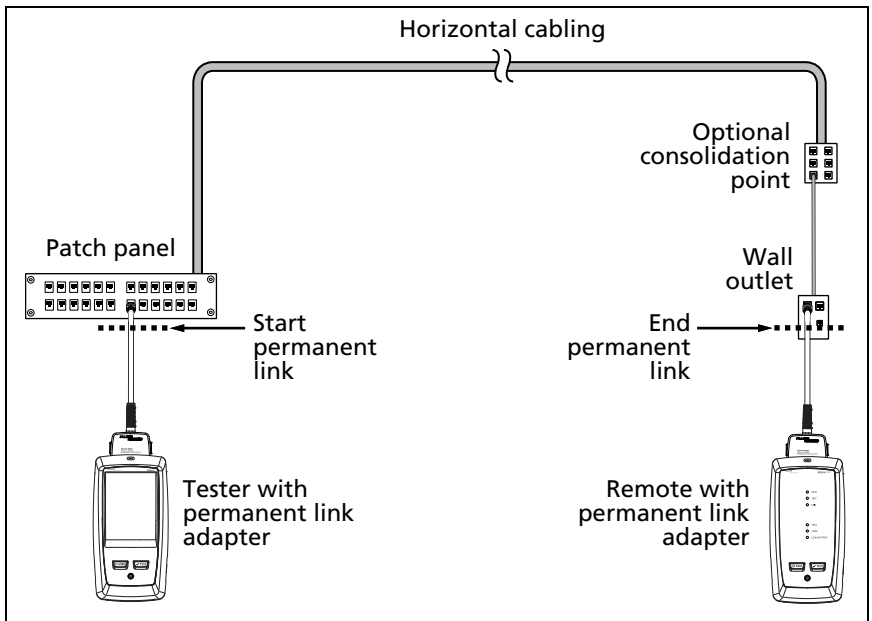

GPU97.EPS

Figure 15. Permanent Link Connections

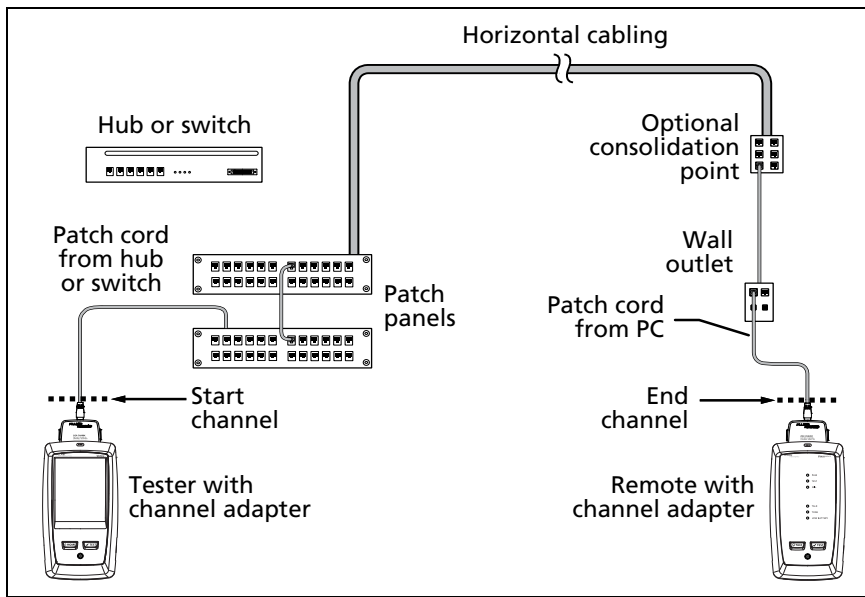

GPU96.EPS

Figure 16. Channel Connections

“Bad Patch Cord” Message

To comply with standards for tests on channels, the tester removes the effects of the channel adapters and their connections from the test results. Before it removes these effects, the tester makes sure that the plugs on the patch cord do not have too much near-end crosstalk (NEXT). Too much NEXT is frequently caused by too much untwisted wire in the plug. If a plug is bad, the tester shows the message **Bad patch cord at main** or **Bad patch cord at remote**, and does not remove the effects of the channel adapters and their connections. The tester saves the message with the results.

If you see one of these messages, replace the patch cord or install a new plug at the bad end.

Twisted Pair Autotest Results

The tests listed below apply to twisted pair cabling.

Note

Some tests are not included in some test limits.

- Wire map
- Resistance
- Resistance unbalance
- Length
- Propagation delay
- Delay skew
- Insertion loss (attenuation)
- Impedance
- NEXT (near-end crosstalk)
- PS NEXT (power-sum near-end crosstalk)
- ACR-N (attenuation to crosstalk ratio at the near end)
- PS ACR-N (power-sum attenuation to crosstalk ratio)
- ACR-F (equal level far-end crosstalk)
- PS ACR-F (power-sum equal level far-end crosstalk)
- Return loss
- TCL (transverse conversion loss)
- CDNEXT (common-mode to differential mode near-end crosstalk)
- CMRL (common-mode return loss)
- ELTCTL (equal level transverse conversion transfer loss)
- HDTD and HDTD_X analyzers (optional tests, not required by any test limit)

PASS*/FAIL* Results

A result shows an asterisk when measurements are in the tester's accuracy uncertainty range (Figure 17) and the asterisk is required by the selected test limit. These results are marginal.

- A **PASS*** shows that the cable's performance is satisfactory. If a cable must get a **PASS** result to agree with your requirements for quality, identify and correct the problems with the cable and do the Autotest again.
- Usually, a **FAIL*** is not a satisfactory result. Identify and correct the problems with the cable and do the Autotest again.

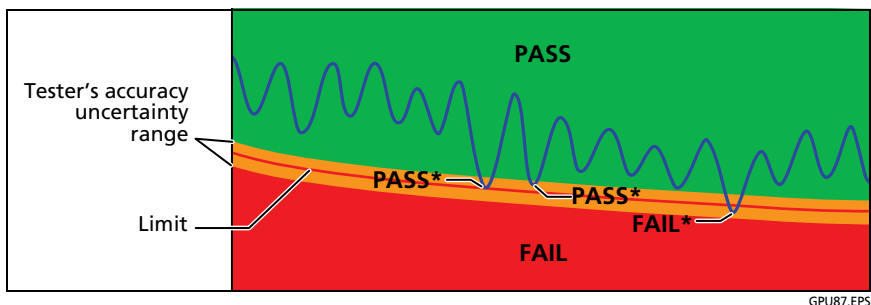
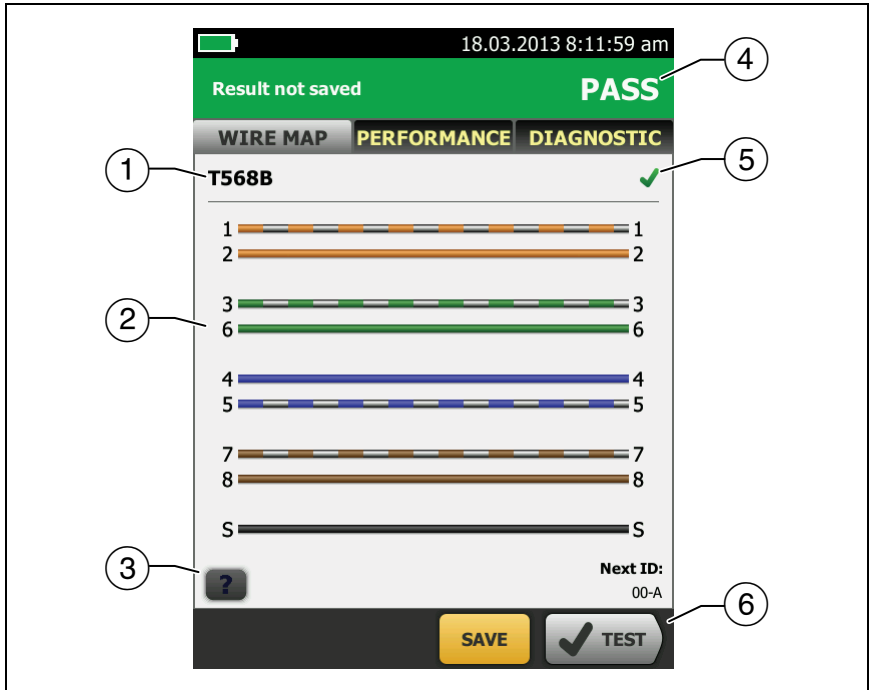

Figure 17. PASS* and FAIL* Results

WIRE MAP Tab

The **WIRE MAP** tab shows the connections between the ends of the cable under test. The tester compares the connections to the selected **Outlet Configuration** to get a **PASS** or **FAIL** result. If the wire map test fails, you can continue or stop the Autotest. Figure 18 shows an example of a wire map screen. For information on AC wire map screens, see the Technical Reference Handbook.



GPU59.EPS

Figure 18. WIRE MAP Tab

- ① The name of the outlet configuration used for the test. The outlet configuration is a setting on the **TEST SETUP** screen.
- ② The wire map of the cabling. The main tester is at the left side of the wire map.
- ③ Tap **?** to see information about wire map faults. If **!** shows, tap it to see a message about the results, such as **Bad patch cord at remote**.
- ④ The overall result for the Autotest. If the result shows an asterisk, See "PASS*/FAIL* Results" on page 40.
- ⑤ The result for the wire map test:
 - ✗ The wire map does not agree with the outlet configuration selected for the test.

- ✔ The wire map agrees with the outlet configuration selected for the test.
- ⑥ When more than one button shows at the bottom of the screen, the tester highlights one in yellow to recommend which one to tap. See “Buttons to Do Tests and Save Results” on page 20.

PERFORMANCE Tab





The **PERFORMANCE** tab (Figure 19) shows the overall result for each test that is required by the selected test limit.



GPU86.EPS

Figure 19. PERFORMANCE Tab

- ① The test limit and cable type used for the test. To see all the settings used for the test, tap the panel.
- ② To see detailed results for a test, tap the panel.

- ③ The overall result for the Autotest. If the result shows an asterisk, See “PASS*/FAIL* Results” on page 40.
- ④ The overall result for the test:
-  The results exceed the limit.
 -  The results are within the limit.
 -  The selected test limit does not have a limit for the test, or a dB rule applies. See the Technical Reference Handbook.
 -  The results are within the range of accuracy uncertainty for the tester. See “PASS*/FAIL* Results” on page 40.
- The measurement shown for frequency-domain results is the worst margin. (The insertion loss plot is different. See the Technical Reference Handbook.)
- ⑤ When more than one button shows at the bottom of the screen, the tester highlights one in yellow to recommend which one to tap. See “Buttons to Do Tests and Save Results” on page 20.

Frequency-Domain Results

Frequency-domain results are the measurements that change with frequency, such as insertion loss and crosstalk.

How to Save Frequency-Domain Results as a Plot or a Table

If **Store Plot Data** is on when you do a test, the saved results show as plots. If **Store Plot Data** is **Off**, the tester does not save plot data for frequency-domain tests or for the HDTDR/HDTDX analyzers. You can see the plots before you save the test and exit the results screen. Figures 20 and 21 show examples of the two types of screens. Also see “Store Plot Data” on page 33.

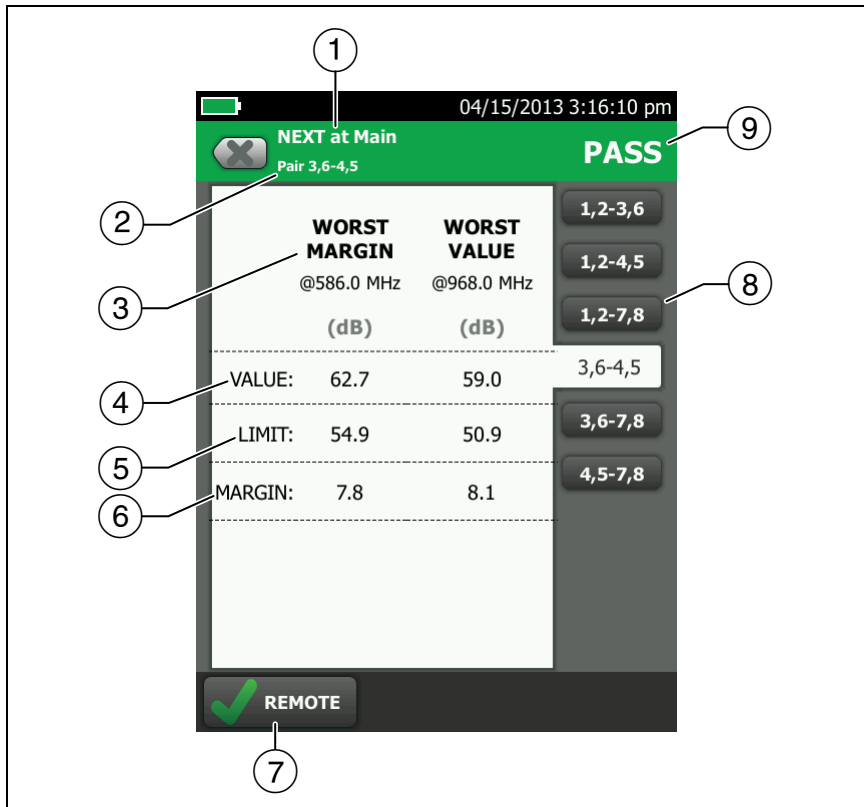

GPU104.EPS

Figure 20. Tabular Results Screen for a Frequency-Domain Test

- ① The location where the tester made the measurements. To switch between results for the main and remote, tap **REMOTE** or **MAIN** (⑦).
- ② The results are for the wire pair or pairs shown. To see the results for a different pair or pairs, tap a tab on the right side of the screen (⑧).
- ③ **WORST MARGIN** is the measurement that is nearest to the limit line or exceeds the limit by the largest amount. **WORST VALUE** is the worst measurement.

- ④ The measured value.
- ⑤ The limit specified by the selected test limit.
- ⑥ **MARGIN** is the difference between the measured value and the limit. The value is in a red box if the measurement exceeds the limit.
- ⑦ To switch between results for the main unit and the remote, tap **REMOTE** or **MAIN**.
- ⑧ To see the results for a different pair or pairs, tap a tab.
- ⑨ The result for the pair. If the result shows an asterisk, see “PASS*/FAIL* Results” on page 40.

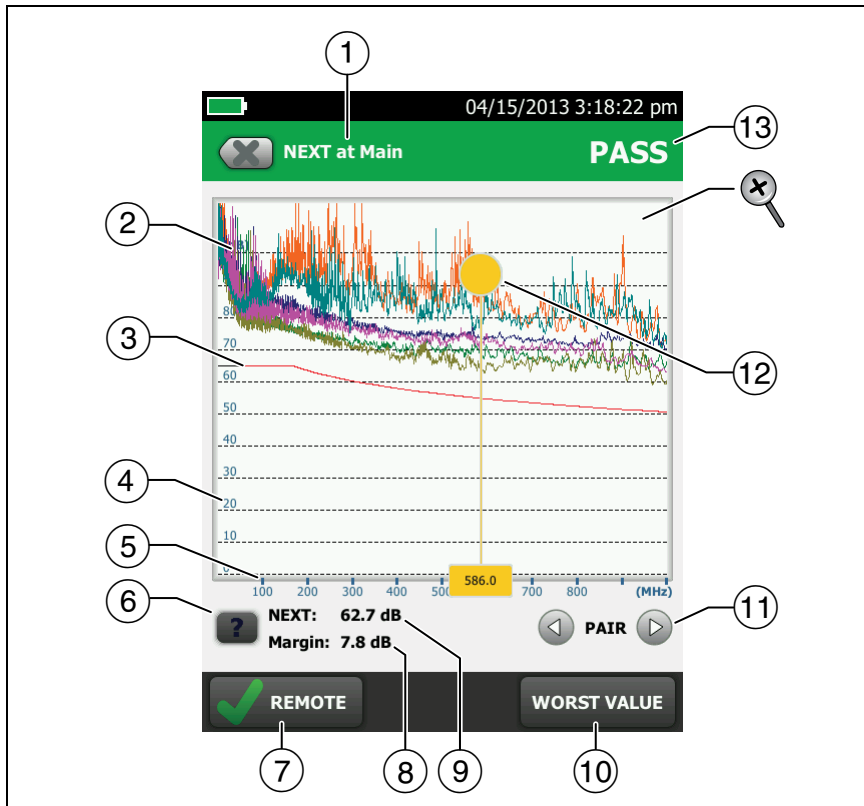





GPU71.EPS

Figure 21. Plot Screen for a Frequency-Domain Test



- ① The location of the measurements. To switch between results for the main and remote, tap **REMOTE** or **MAIN** (⑦).
- ② Measured values for the wire pairs.
- ③ The limit line (in red) for the measurement.

Note

If the limit line is black, the tester does not evaluate the measurement at those frequencies because a dB rule applies. See the Technical Reference Handbook.

- ④ The vertical scale is the measured value in decibels.
- ⑤ The horizontal scale is the frequency range in megahertz.
- ⑥ To see help for the screen, tap .
- ⑦ To switch between results for the main unit and the remote, tap **REMOTE** or **MAIN**.
- ⑧ The margin at the cursor's location. The margin is the difference between the measured value and the limit. The margin is negative if the pair failed.
- ⑨ The measured value at the cursor's location.
- ⑩ When you first look at the plot, the cursor is at the frequency of the worst margin. To move the cursor to the worst value, tap **WORST VALUE**. (The insertion loss plot is different. See the Technical Reference Handbook.)
- ⑪ To see the plots for pairs, tap  or . To select pairs to show on the plot, touch  or  for one second to see the **SELECT PAIRS** window. Select the pairs you want to see, then tap **OK**.
- ⑫ When you first look at the plot, the cursor is at the frequency of the worst margin. To move the cursor to the worst value, tap **WORST VALUE** (⑩). The box at the bottom of the cursor shows the frequency at the cursor's position.

To move the cursor to other points, touch and drag the yellow circle at the top of the cursor.

To move the cursor in small increments, tap the yellow circle, then tap the arrow buttons that show on the plot ( or .
- ⑬ The overall result for the test. If you look at pairs, the result is for those pairs. If the result shows an asterisk, see "PASS*/FAIL* Results" on page 40.
-  To zoom in and out, use the pinch, reverse-pinch, and double-tap gestures on the touchscreen. You can also use the zoom controls to change the magnification on the frequency and decibels scales independently. See Figure 6 on page 19.

DIAGNOSTIC Tab

If the Autotest failed or had a marginal result, or if you selected **All Autotests** for the **HDTDR/HDTD** setting on the **TEST SETUP** screen, the **DIAGNOSTIC** tab gives you access to the HDTDR and HDTD analyzer plots. The plots help you locate the causes of NEXT and return loss failures. See the Technical Reference Handbook.

Chapter 3: Test Results

View Saved Results

On the home screen, tap the **RESULTS** icon. The **RESULTS** screen shows the results in the active project. See Figure 22.

To organize results and make reports you can give to customers, use LinkWare software.

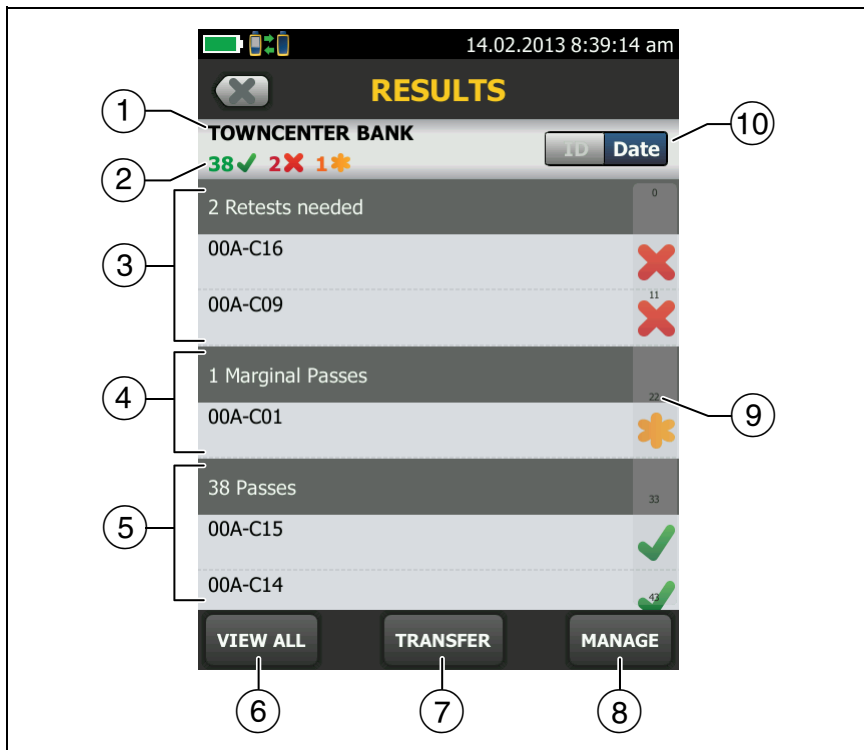

HEJ24.EPS

Figure 22. RESULTS Screen



- ① The name of the active project.
- ② ✓: The number of results that passed. This includes individual results for each ID and tests that have an **i** result.

✗: The number of results that failed. This includes individual results for each ID.

✳: The number of results that have measurements within the range of accuracy uncertainty for the tester. See "PASS*/FAIL* Results" on page 40.

Note

These numbers show the total number of results that passed and failed in the IDs saved. So, the numbers can be more than the number of IDs saved.

- ③ The cable IDs that have **FAIL** results and must be tested again. Because some IDs can have one or more tests that failed, the number at the top of this screen (②) can be more than the number of retests needed.
- ④ The cable IDs that have measurements within the range of accuracy uncertainty for the tester. See “PASS*/FAIL* Results” on page 40.
- ⑤ The cable IDs that have an overall **PASS** or  result. Because some IDs can have one or more tests that passed or have an  status, the number at the top of this screen (②) can be more than the number of passes.
- ⑥ Tap **VIEW ALL** to see a summary of the results in all the projects in the tester.
- ⑦ **TRANSFER** lets you export or import results to or from a flash drive and delete results on the flash drive.
- ⑧ **MANAGE** lets you move results to a different project, rename results, or delete results that are in the tester.
- ⑨ The scroll bar shows when the list of results is long. To use the scroll bar, tap on the bar or slide your fingertip on the bar. For example, to see the 12th result in the list, tap on “12” in the scroll bar. When you slide your fingertip on the bar, the number of the result you can see is next to your fingertip.
- ⑩ Tap the **ID/Date** control to sort the results by cable ID or by date. When you sort by ID, the results show in ascending order. When you sort by date, the latest result is at the top of the list.

How to Replace a Saved Result that Failed

To use the same test settings that were used for the saved result

- 1 On the home screen, tap the **RESULTS** icon.
- 2 On the **RESULTS** screen, tap a result that failed.
- 3 Tap **TEST AGAIN**.
- 4 When the test is completed, and if **Auto Save** is on, the tester asks you if you want to overwrite the results. Tap **Yes**.

If **Auto Save** is off, tap **FIX LATER** (if the test failed) or **SAVE** (if the test passed) to save the result.

To replace a result with a result that uses different test settings

- 1 Turn off **Auto Save**.
- 2 Make sure that the home screen shows the project that contains the result you want to replace.
- 3 Select the necessary test settings.
- 4 Do the test, tap **FIX LATER** (if the test failed) or **SAVE** (if the test passed), then enter the ID of the saved result.
- 5 The tester asks you if you want to overwrite the results. Tap **Yes**.

Delete, Rename, and Move Results

Before you delete, rename, or move results, select the project that contains the results and go to the **MANAGE RESULTS** screen:

- 1 On the home screen, tap the **RESULTS** icon. The **RESULTS** screen shows the results in the active project.
- 2 To see the results in another project, tap **VIEW ALL**, then tap a project.
- 3 Tap **MANAGE** to see the **MANAGE RESULTS** screen.

To delete results

- 1 On the **MANAGE RESULTS** screen, select the results you want to delete.

To select all the tests that failed or all the tests that passed, tap **Select All Retests** or **Select All Passes**.

- 2 Tap **DELETE**, then tap **DELETE** in the confirmation dialog.

To rename results

- 1 On the **MANAGE RESULTS** screen, select one result to rename.
- 2 Tap **RENAME**.
- 3 Enter a new name, then tap **DONE**.

To move results to a different project

- 1 On the **MANAGE RESULTS** screen, select the results you want to move.
- 2 Tap **MOVE**.
 - To move the results to a project shown in the list, tap the project name, then tap **MOVE** in the confirmation dialog.
 - To make a new project and move the results to the new project, tap **NEW PROJECT**, enter a project name, tap **DONE**, then tap **MOVE** in the confirmation dialog.

Note

When you move results to a different project, that project becomes the active project.

Manage Results on a Flash Drive

You can export or import results to or from a flash drive, and delete results on the flash drive.

Caution

- Do not remove the USB flash drive while the LED on the drive flashes. Doing so can corrupt the data on the drive.
- You can lose a USB flash drive, cause damage to it, or accidentally erase the contents of the drive. Thus, Fluke Networks recommends that you save no more than one day of test results on a flash drive.

Note

The tester reads only USB drives that use the FAT format.

- 1 Connect a USB flash drive to the type A USB port. The tester makes a bell sound when it detects the drive.
- 2 On the home screen, tap the **RESULTS** icon.
- 3 The **RESULTS** screen shows the results in the active project. To export results from a different project, tap **VIEW ALL** then tap a project.
- 4 Tap **TRANSFER**.
- 5 On the **TRANSFER RESULTS** screen, select a function:
 - **Export**: On the **EXPORT RESULTS** screen, select **New** or **All**, select the project that contains the results you want to export to the flash drive, then tap **EXPORT**.

New: Export only results that do not have the same IDs as results that are already on the flash drive. **All**: Export all the results from all projects in the tester.

Note

Cable IDs are case-sensitive. For example, the tester saves result with the names "A0" and "a0" in two different records.

If you select the active project, the **EXPORT RESULTS** screen shows the percentage of tests completed for the project and the percentage of results already exported to a flash drive.

- **Import:** On the **IMPORT RESULTS** screen select the project that contains the results you want to import from the flash drive, then tap **IMPORT**.
- **Delete:** On the **DELETE RESULTS** screen select the project that contains the results you want to delete on the flash drive, then tap **DELETE**.

Upload Results to a PC

To upload results to a PC from the tester or a flash drive, use LinkWare software.

- 1 Install the latest version of LinkWare software on the PC.
- 2 Turn on the tester and start LinkWare on the PC.
- 3 Use the USB cable supplied to connect the Micro-AB USB port on the tester to a type A USB port on the PC. See Figure 23.

Or connect a USB flash drive to the PC.

- 4 On the LinkWare toolbar, click , then select **DSX CableAnalyzer** to upload from a tester, or **Test Files (.tst)** to upload from a flash drive.
- 5 In the **Import** dialog box in LinkWare, select options for the location and the number of results to import.

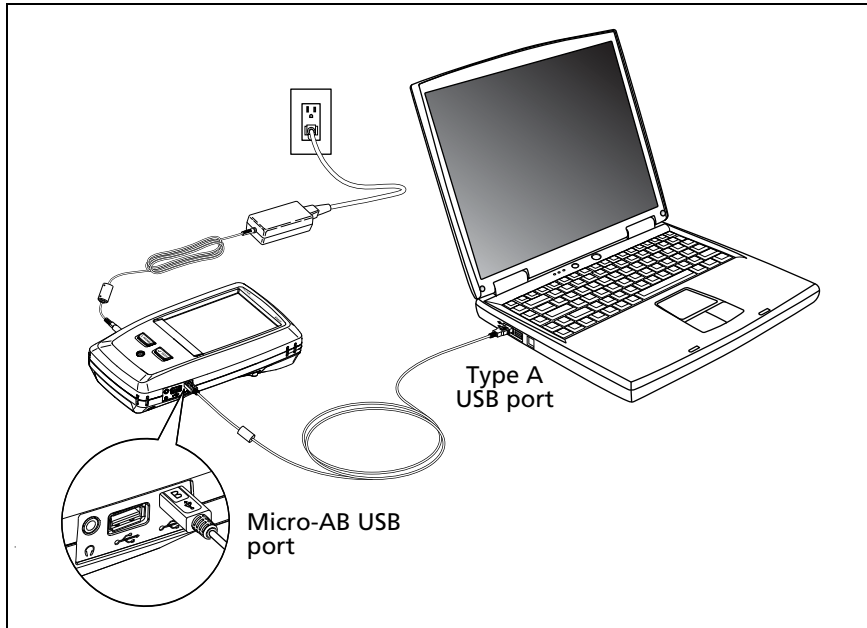

GPU46.EPS

Figure 23. How to Connect the Tester to a PC

View the Memory Status

To see the memory status

On the home screen, tap the **TOOLS** icon, then tap **Memory Status**.

The **MEMORY STATUS** screen shows these values:

- The percentage of memory available
- The number of test records that are saved
- The number of .id files that have been downloaded to the tester from LinkWare software
- The memory space taken by other files, such as the databases for projects and test limits

Chapter 4: Projects

Why Use Projects?

Projects help you monitor the status of a job and make sure that your work agrees with the requirements of the job.

You can use a project to do these tasks:

- Specify the tests that are necessary for a job.
- Specify settings for tests.
- Specify an operator for the job.
- Make sets of sequential IDs to use as names for test results.
- Automatically save test results with IDs from a set.
- Add the results from other necessary tests to each saved result in the project.
- See which IDs do not have results for a specified test.
- See what percentage of a job is completed.
- See how many links passed and how many failed.
- Keep the test results from a job in one place for easy access.

When you use a project, you can do tests and use IDs that are not specified in the project if necessary. You can also easily change the settings in a project if necessary.

Note

It is not necessary to install a module to set up a project for the module. The tester keeps all settings in the main Versiv unit.

Set Up a Project

Refer to the **PROJECT** screen in Figure 24 on page 61.

- 1 On the home screen, tap the **PROJECT** panel, tap **CHANGE PROJECT**, then tap **NEW PROJECT**.
- 2 On the **NEW PROJECT** screen, enter a name for the project, then tap **DONE**.
- 3 On the **PROJECT** screen, tap the **Operator** panel to enter an operator name for the project.
- 4 On the **PROJECT** screen, tap the **NEW TEST** button to enter the tests and test settings necessary for the project.
- 5 On the **PROJECT** screen, tap the **NEW ID SET** button to make one or more sets of cable IDs for the project. See the **CABLE ID SETUP** screen in Figure 25 on page 64.
- 6 On the **PROJECT** screen, tap **DONE**.

The PROJECT Screen

To start a new project, tap the **PROJECT** panel on the screen. Figure 24 shows the **PROJECT** screen and describes the items you enter to make a project.



GPU08.EPS



Figure 24. PROJECT Screen

- ① The name of the project. See also item ⑨.
- ② **Operator:** The name of the person who will do the tests for the project.
- ③ The date range for the results in the project.
- ④ **Results:** A summary of the test results in the project:

✘: The number of tests that failed.

✔: The number of tests that passed.

✿: The number of results that have measurements within the range of accuracy uncertainty for the tester. See "PASS*/FAIL* Results" on page 40.

- ⑤ **Test Setup:** The tests that are available in the project.
To add a test to the project, tap **NEW TEST**.
- ⑥ **Cable ID Sets:** The sets of IDs the tester can use for the names of test results. Each ID set is for either copper or fiber cable.
To add a set of IDs to the project, tap **NEW ID SET**. See Figure 25.
- ⑦ To use a different project, tap **CHANGE PROJECT**, then tap a project.
To make a new project, tap **CHANGE PROJECT**, then tap **NEW PROJECT**.
- ⑧ **TRANSFER** lets you export or import projects to or from a flash drive and delete projects on the flash drive. The project data includes all project settings and test results.
- ⑨ **MANAGE** lets you rename, copy, or delete a project that is in the tester.
- ⑩ To delete the test setup or ID set, tap . To copy the test setup or ID set so you can edit it to make a new one, tap .

Notes

If you delete an imported ID set from a project, the ID set is still available in the tester. To delete imported ID sets from the tester, use LinkWare software.

*A project must have at least one **Test Setup** and one **Cable ID** set. If you delete them all, the tester makes a default **Test Setup** and **Cable ID** set.*

The CABLE ID SETUP Screen

To see the **CABLE ID SETUP** screen, tap the **PROJECT** panel on the home screen, then tap **NEW ID SET** on the **PROJECT** screen. See Figure 25 on page 64.

Each project can have up to 5000 IDs. If an ID set does not have a **Last ID**, the tester counts the set as one ID. An ID can have a maximum of 60 characters. Symbols, such as the asterisk, and accented characters do not increment.

About Next ID Sets

If you do not enter a **Last ID** when you make an ID set, the tester uses the **First ID** as the **Next ID**. The tester increments the Next ID each time you save a result.

- Numbers increment sequentially:
1, 2, 3, 4, 5, 6, 7, 8, 9, 10, 11, 12, ... 99, 100, 101...
- Letters increment through the English alphabet:
A, B, C, D, ... Z, AA, AB, AC, AD, ... AZ, BA, BB, BC...
- Numbers and letters do not cause each other to increment:
1Y, 1Z, 1AA, 1AB, ... 1ZZ, 1AAA, 1AAB...
- The tester does not increment symbols or accented characters.

When you use a **Next ID** set, the set under **IDs Untested** on the **CHANGE ID** screen shows only the next ID. To save the next test with a different ID, tap the **Next ID:** panel, then enter a different ID.

Each project can have one **Next ID** set.

If your project has only a **Next ID** set, the tester cannot calculate the percentage of the project that is completed, so the **% Tested** value does not show on the home screen.

If your project has both a **Next ID** set and sets with first and last IDs, the **% Tested** value includes tests you saved with **Next ID**. For

example, if you have one **Next ID** set and one set with 10 IDs, and you save 10 results with next IDs, the **% Tested** shows 50% (10 saved results divided by 20 IDs).

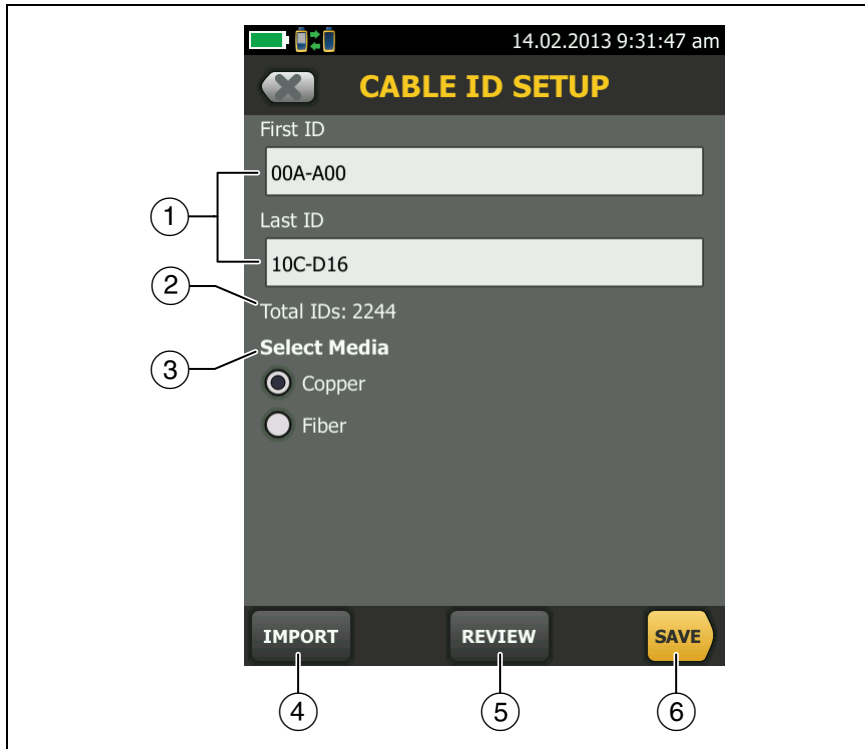

HEJ09.EPS

**Figure 25. CABLE ID SETUP Screen
(after you enter the first and last IDs)**

- ① **First ID and Last ID:** The first and last IDs in a set of sequential IDs.

If you do not enter a **Last ID** when you make an ID set, the tester will increment the **First ID** to make subsequent IDs.

Note

The tester does not increment symbols or accented characters.

When you use an ID set that does not have a **Last ID**, the set under **IDs Untested** on the **CHANGE ID** screen shows only the next ID.

- ② **Total IDs:** The number of IDs in the set. This section does not show for ID sets that do not have a **Last ID**.
- ③ **Select Media:** Select **Copper** to use the ID set to save results from tests on copper cable.

Note

*If you select **Fiber**, the ID set will not be available when you do a copper test.*

- ④ Tap **IMPORT** to use an ID set that you downloaded to the tester from LinkWare software.
- ⑤ Tap **REVIEW** to see the **CABLE ID REVIEW** screen, which shows the ID set and the total number of IDs.

Note

*The **REVIEW** button does not show if you do not enter a **Last ID**.*

- ⑥ **SAVE:** To save the ID set, tap **SAVE**.

Manage Projects on a Flash Drive

You can export or import projects to or from a flash drive, and delete projects on the flash drive. The project data includes all project settings and test results.

Caution

- **Do not remove the USB flash drive while the LED on the drive flashes. Doing so can corrupt the data on the drive.**
- **You can lose a USB flash drive, cause damage to it, or accidentally erase the contents of the drive. Thus, Fluke Networks recommends that you save no more than one day of test results on a flash drive.**

Note

The tester reads only USB drives that use the FAT format.

- 1 Connect a USB flash drive to the type A USB port. The tester makes a bell sound when it detects the drive.
- 2 On the home screen, tap the **PROJECT** panel.
- 3 On the **PROJECT** screen, tap **TRANSFER**.
- 4 On the **TRANSFER PROJECTS** screen, select a function:
 - **Export:** On the **EXPORT PROJECTS** screen, select the projects you want to export to the flash drive, then tap **EXPORT**.
 - **Import:** On the **IMPORT PROJECTS** screen select the projects you want to import from the flash drive, then tap **IMPORT**.
 - **Delete:** On the **DELETE PROJECTS** screen select the projects you want to delete on the flash drive, then tap **DELETE**.

Copy Project Settings to Other Testers

To copy the settings in a project to other Versiv units, use the **Read Project Setups** and **Write Project Setups** utilities in LinkWare software. You can use LinkWare to read project settings from a tester or from a project you exported to a flash drive.

Chapter 5: Maintenance

Warning

To prevent possible fire, electric shock, personal injury, or damage to the tester:

- Do not open the case. You cannot repair or replace parts in the case.
- Use only replacement parts that are approved by Fluke Networks.
- If you replace parts that are not specified as replacement parts, the warranty will not apply to the product and you can make the product dangerous to use.
- Use only service centers that are approved by Fluke Networks.

Caution

If you replace electrical parts yourself, the tester will possibly not have the correct calibration and can give incorrect test results. If the calibration is not correct, cable manufacturers can remove their warranty from the cabling you install.

Verify Operation

The tester does a self test when you turn it on. If the tester shows an error or does not turn on, refer to “If the Tester Does Not Operate as Usual” on page 76.

Clean the Tester

To clean the touchscreen, turn off the tester, then use a soft, lint-free cloth that is moist with water or water and a mild detergent.

To clean the case, use a soft cloth that is moist with water or water and a mild detergent.



Do not put the tester or the battery pack in water.



To prevent damage to the touchscreen or the case, do not use solvents or abrasive materials.

When you clean the touchscreen or the case, do not let liquid get under the plastic around the touchscreen.

Traceable Calibration Period

To make sure that the modules operate within the published specifications for accuracy, have them calibrated at a Fluke Networks authorized service center every 12 months.

See Information About the Tester

To see information about your tester and attached modules and adapters

On the home screen, tap the **TOOLS** icon, then tap **Version Information**.

To see information about a remote tester

Use DSX CableAnalyzer modules and adapters to connect the main and remote testers together (see Figure 5 on page 17), then tap **REMOTE** on the **Version Information** screen.

Update the Software

New software gives you access to new features and the latest test limits and cable types. Software updates are available on the Fluke Networks website.

You can use a PC to install a software update, or connect an updated main unit to a remote or to another main unit to update those units.

To use a PC to update the software



Caution

To prevent unexpected loss of power, connect the ac adapter to the tester when you update the software.

Note

The software update procedure does not delete the test records, project settings, or user preferences in the tester, but can possibly change the factory-installed cable types or test limits.

- 1 Install the latest version of LinkWare software on your PC. LinkWare is available on the Fluke Networks website.
- 2 Download the Versiv update file from the Fluke Networks website, or contact Fluke Networks to get the update by other methods. Save the file to your hard drive.
- 3 Connect the AC adapter to the tester and connect the Micro-AB USB port on the tester to a USB port on the PC. See Figure 26.

- 4 On the LinkWare menu, select **Utilities > DSX CableAnalyzer > Software Update**, find and select the update file, then click **Open**. LinkWare saves the update file on the tester, then the tester installs the file.
- 5 The tester reboots when the update is completed. To make sure the update was installed correctly, tap the **TOOLS** icon on the home screen, tap **Version Information**, then make sure the Versiv main unit and the module show the correct version.
- 6 Do steps 3 through 5 again for the remote. On a remote tester, the LEDs show the progress of the installation.

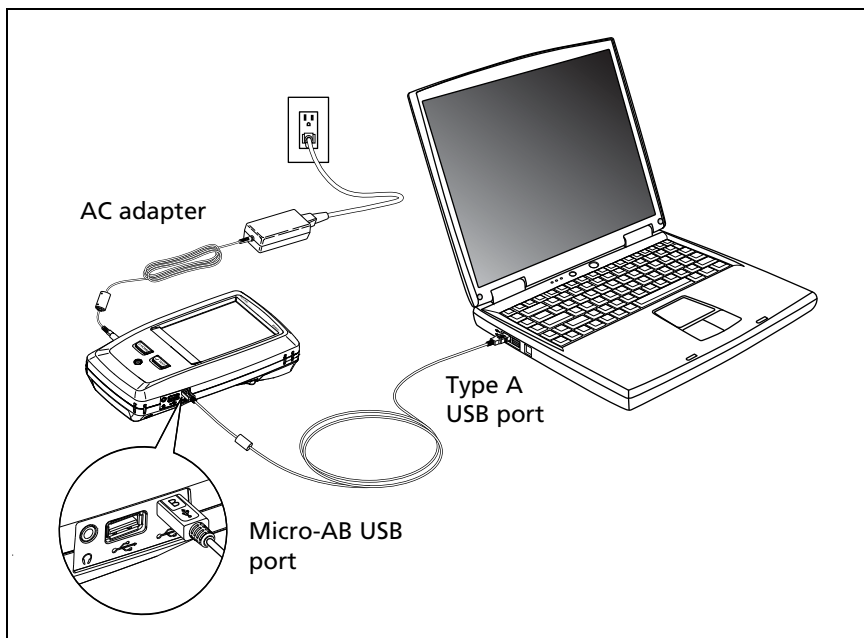

Figure 26. How to Connect the Tester to a PC

To use an updated main unit to update a remote or another main unit

- 1 Turn on both testers and connect the AC adapters to both testers.
- 2 Use the USB cable provided to connect the updated main unit to the remote or to another main. See Figure 27.
- 3 Follow the instructions shown on the display of the updated main unit.

Note

If a remote has newer software than the main unit, the main unit can install the older software in the remote so that you can use the two units together. The remote cannot install the newer software in the main unit.

To update the software in a module

To update the software in a module, attach it to a main or remote Versiv unit that has the latest software. The tester automatically installs the software in the module.

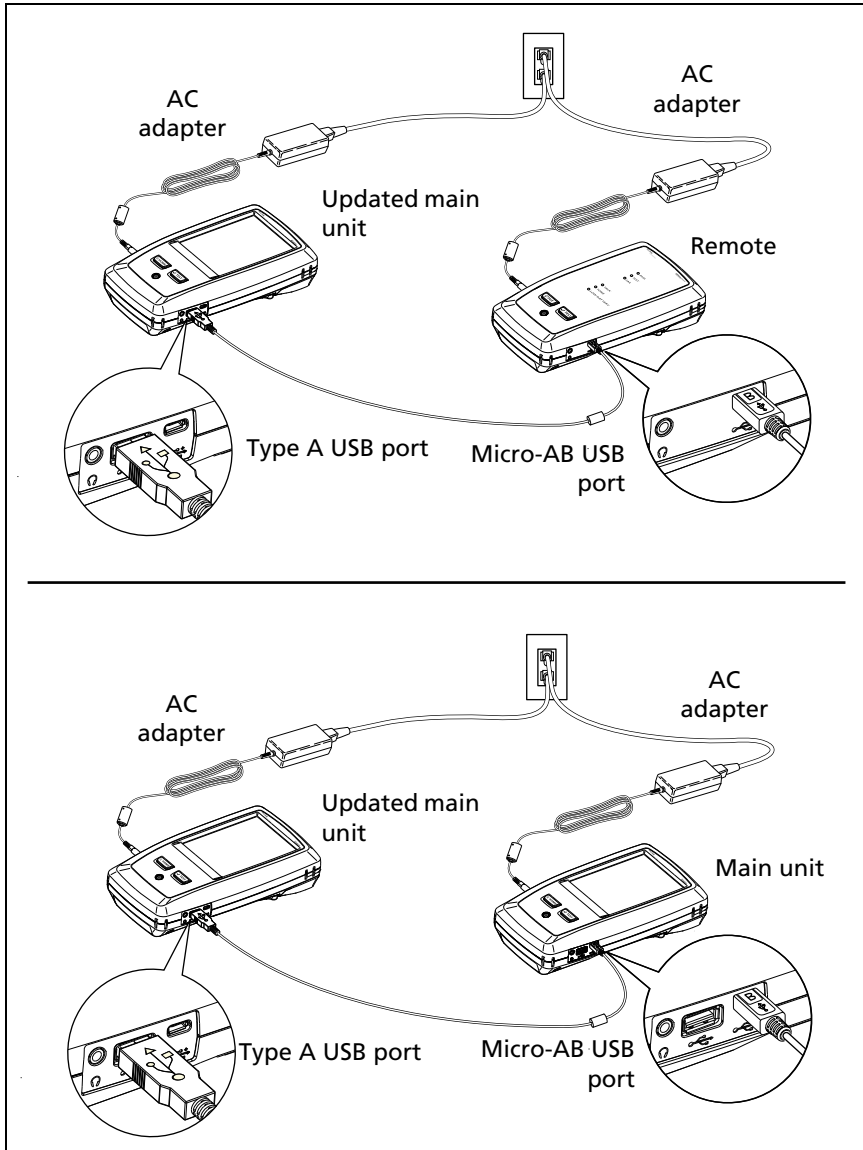

GPU116.EPS

Figure 27. How to Connect Units Together to Update the Software

Extend the Life of the Battery

- Do not frequently let the battery discharge completely.
- Do not keep the battery at temperatures below $-20\text{ }^{\circ}\text{C}$ ($-4\text{ }^{\circ}\text{F}$) or above $+50\text{ }^{\circ}\text{C}$ ($+122\text{ }^{\circ}\text{F}$) for periods longer than one week.
- Before you put a battery into storage, charge it to approximately 50 % of full charge.

Store the Tester

- Before you store a tester or an extra battery for a long period, charge the battery to approximately 50 % of full charge. The discharge rate of the battery is 5 % to 10 % each month. Check the battery every 4 months and charge it if necessary.
- Keep a battery attached to the tester during storage. If you remove the battery for more than approximately 24 hours, the tester will not keep the correct time and date.
- Storage temperature: $-22\text{ }^{\circ}\text{F}$ to $+140\text{ }^{\circ}\text{F}$ ($-30\text{ }^{\circ}\text{C}$ to $+60\text{ }^{\circ}\text{C}$)

Remove the Battery

Figure 28 shows how to remove the battery.

Notes

If you remove the battery and do not connect the AC adapter, the clock keeps the current date and time for a minimum of 24 hours.

The screw does not come out of the battery door.

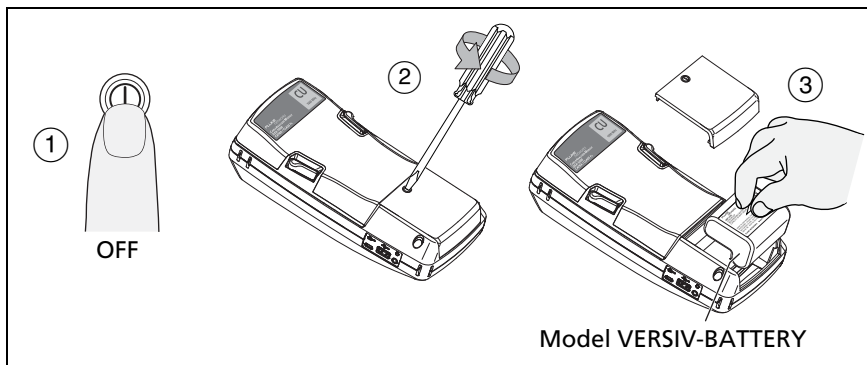

Figure 28. How to Remove the Battery

GPU21.EPS

Calibration

To make sure that the modules operate within the published specifications for accuracy, have them calibrated at a Fluke Networks authorized service center every 12 months. To get information on factory calibration, contact an authorized Fluke Networks Service Center.

To see when the tester last received a factory calibration, tap the **TOOLS** icon on the home screen, then tap **Version Information**.

If the Tester Does Not Operate as Usual

If the tester does not operate as usual or if it shows an unusual message, see Table 3 for possible explanations and solutions to some conditions that can occur.

If the condition continues, contact Fluke Networks for assistance, or search the Fluke Networks Knowledge Base for a solution.

If you contact Fluke Networks, have available the serial number, software and hardware versions, and calibration date for the tester, if possible. To see this information, tap the **TOOLS** icon on the home screen, then tap **Version Information**.

You can also use LinkWare software to upload the system log from the tester. This file contains information that can possibly help Fluke Networks find a solution to an unusual problem.

To see the serial numbers of the main and remote units and modules if the tester is not operating correctly, remove the module and look at the stickers under and on the module.

Table 3. Possible Solutions for Unusual Behavior

<p>The touchscreen or the keys do not respond.</p> <p>Press and hold  until the tester turns off. Then turn on the tester. If the problem continues, install the latest version of software in the tester.</p>
<p>The tester will not turn on even though the battery is charged.</p> <p>The fuse in the battery is possibly open. Connect the AC adapter. The tester can operate on AC power if the battery does not operate.</p>
<p>Test results appear to be incorrect.</p> <p>The tester possibly has incorrect settings. Make sure you selected the correct cable type and test limit.</p>

Options and Accessories

To order options and accessories, contact an authorized Fluke Networks distributor.

Certifications and Compliance

	<p>Conformite Europeene. Conforms to the requirements of the European Union and the European Free Trade Association (EFTA).</p>
	<p>Listed by the Canadian Standards Association.</p>
	<p>Conforms to relevant Australian standards.</p>
	<p>Conforms to relevant Russian standards.</p>
	<p>KCC-REM-FKN-012001001: EMC approval for Korea Class A Equipment (Industrial Broadcasting & Communication Equipment)</p> <p>This product meets requirements for industrial (Class A) electromagnetic wave equipment and the seller or user should take notice of it. This equipment is intended for use in business environments and is not to be used in homes.</p> <p>A 급 기기 (업무용 방송통신기자재)</p> <p>이 기기는 업무용 (A 급) 전자파적합기기로서 판매자 또는 사용자는 이 점을 주의하시기 바라며 , 가정외의 지역에서 사용하는 것을 목적으로 합니다 .</p>

Regulatory Information

This equipment generates, uses, and can radiate radio frequency energy, and, if not installed and used in accordance with the manual, may cause interference to radio communications. It has been tested and found to comply with the limits for a Class A digital device pursuant to Part 15, Subpart J of the FCC rules, which are designed to provide reasonable protection against such interference when operated in a commercial environment. Operation of the equipment in a residential area is likely to cause interference, in which case the user, at his own expense, will be required to take whatever measures may be required to correct the interference.

Index

Symbols

* in results, 40

% Tested, 14

–A–

ac adapter, 15

AC wire map, 34

accessories

ordering, 77

standard, 7

alien crosstalk, 28

asterisk in results, 40

auto save

description, 23

how to turn on, 23

Autotest

asterisk in results, 40

do an Autotest, 36

results, 39

settings, 31

AxTalk, 28

–B–

bad patch cord, 38

battery

care, 75

charging, 15

removal, 75

status, 15

storage, 75

–C–

cable ID setup screen, 64

cable type (twisted pair), 32

channel connections, 38

cleaning

case, 70

touchscreen, 70

connectors on the testers, 8

contact Fluke Networks, 5

customer support, 5

–D–

diagnostic tab, 48

display

cleaning, 70

how to use, 18

–F–

FAIL*, 40

fix later, 21

flash drive

projects, 66

results, 54

Fluke Networks

contact, 5

Knowledge Base, 6

–H–

HDTDR/HDTDX, 33, 48

help (contact Fluke Networks), 5

home screen, 12

–I–

i, 43

ID set

copy, 62

delete, 62

- import, 65
- make an ID set, 63
- maximum number of IDs, 63
- next ID, 63, 65
- options, 22

–K–

- Knowledge Base, 6

–L–

- language, 20
- link interface adapters, 24
- LinkWare and LinkWare Stats, 28

–M–

- maintenance, 69
- memory
 - capacity, 22
 - flash drive
 - projects, 66
 - results, 54
 - status, 22, 57
 - upload results to a PC, 55
- module
 - connectors, 8
 - install or remove, 26
 - twisted pair settings, 32

–N–

- next ID
 - about next ID sets, 63
 - on home screen, 13
- NVP, 32

–O–

- operator, 13
- options and accessories, 77
- outlet configuration, 33

–P–

- parts, 77
- PASS*, 40
- performance tab, 42
- permanent link connections, 37
- plots (twisted pair)
 - description, 46
 - store plot data, 33
- PoE, 34
- project
 - copy to another tester, 67
 - flash drive, 66
 - project screen, 61
 - purpose, 59
 - set up a project, 60

–R–

- reference, 30
- remote tester
 - battery status, 16
 - LEDs, 10
 - version information, 71
- replacement parts, 77
- results
 - delete, rename, move, 52
 - flash drive, 54
 - replace a saved result, 52
 - results screen, 50
 - table or plot, 43
 - upload to a PC, 55

–S–

- self test, 70
- service, 76
- settings for twisted pair tests
 - settings used, 42
 - test setup screen, 31
- shield test, 32
- software
 - update, 71

version, 70
storage, 75
store plot data, 33
system log, 77

-T-

talk, 14
test again, 22
test limit, 32
test setup
 add to a project, 62
 copy, 62
 delete, 62
touchscreen
 cleaning, 18
 how to use, 18
twisted pair
 See *also* Autotest
 reference, 30
 results, 39
 settings, 31
 test, 37

-V-

version information, 70

-W-

warnings, 69
wire map
 AC wire map
 setting, 34
 results, 41



99 Washington Street
Melrose, MA 02176
Phone 781-665-1400
Toll Free 1-800-517-8431

